



# Fetal Monitoring with Body Sensor Networks

Michael Korostelev\*, Li Bai, PhD<sup>†</sup>, Jie Wu, PhD<sup>‡</sup>, Dimitrios S. Mastrogiannis, MD, PhD, FACOG<sup>§</sup>

## Current Fetal Monitoring Procedure and Cardiotocography Apparatus

### Uterine activity

### Fetal heart rate



Internal

External

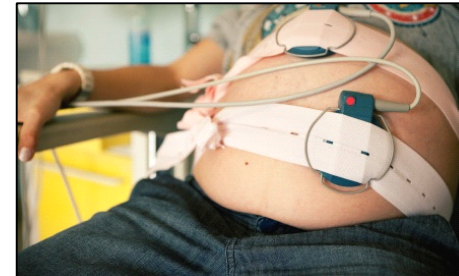
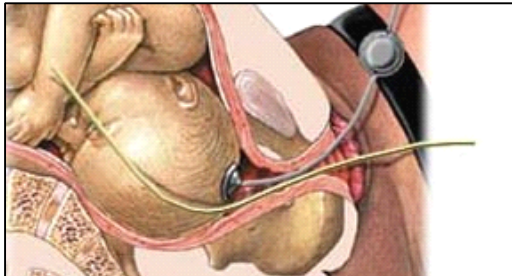

- Used once water is broken
- Monitoring through direct contact with fetus
- Higher precision and consistency

- Used intermittently through pregnancy
- Ultrasound Doppler device, pressure gauge
- Sensor devices wired to monitor

## Fetal Monitor Patterns

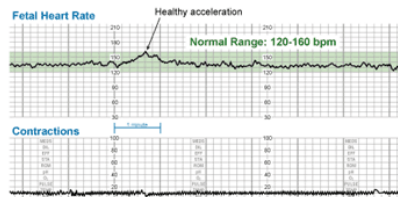

**Reassuring Pattern**

Baseline fetal heart rate is 120-160, preserved beat-to-beat and long-term variability. Accelerations last for 15 or more seconds above baseline, and peak to 15 or more bpm.

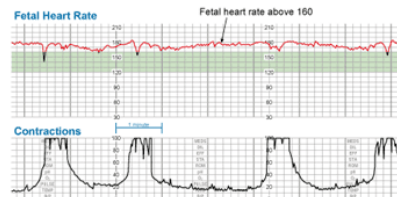

**Elevated Heart Rate: Tachycardia**

Baseline fetal heart rate is above 160, possible onset of decreased variability. Usually due to fetus lacking nourishing blood supply, or resultant effects of some drugs.

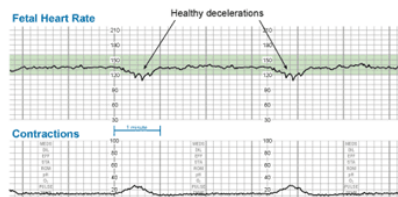

**Early Deceleration**

The onset and the return of the deceleration coincides with the start and the end of the contraction. Decelerations are associated with fetal movement, stimulation, and uterine contractions.

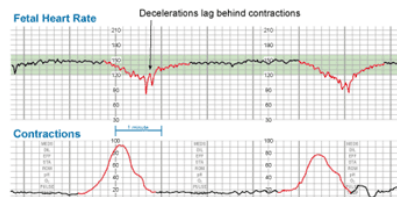

**Late Deceleration with Preserved Variability**

Fetal heart rate returns to baseline AFTER the contraction has ended. Late decelerations are associated with uteroplacental insufficiency, or decreased uterine bloodflow.

© 2007 AMICUS Visual Solutions

- Access right types for: physician, nurse, support staff, patient
- Annotations and time-stamping
- Data as medical record security
- Emotional engagement of patient
- Notification
- Situational awareness for patient
- Real-time charts and plotting of data
- Data retention
- Append only logging
- Monitoring interruption detection
- Slow sampling rate, long monitoring  
3 second interval, monitoring time 1-2 hours

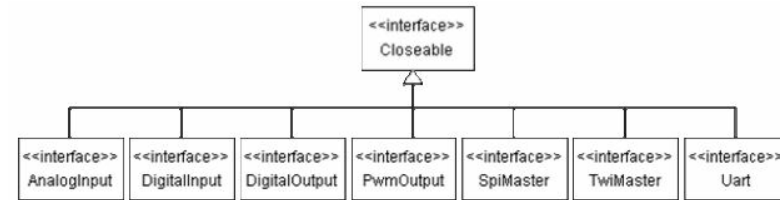
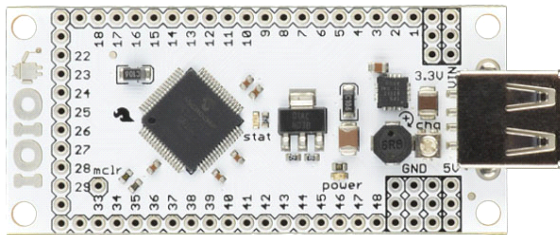
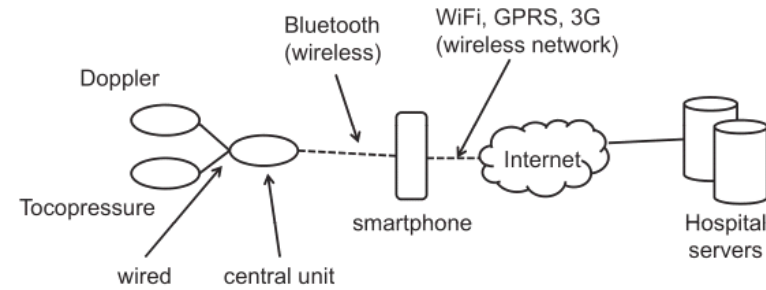
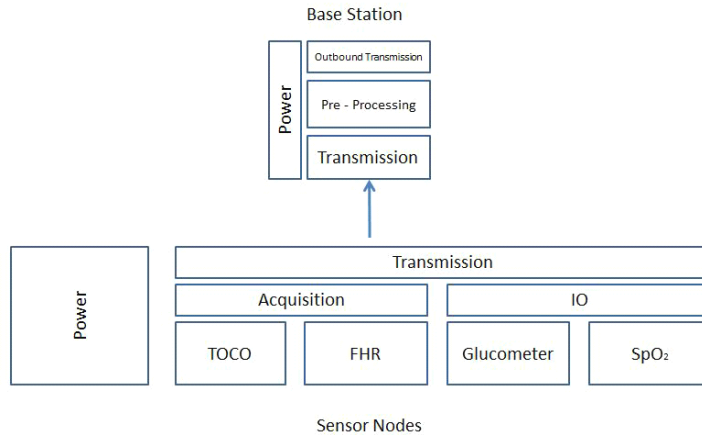

- Integration Platform - PIC24 MCU + Android ADK

Digital Input/Output, PWM, Analog Input, I2C, SPI, and UART - Interface with existing medical equipment

**Access control.** The system needs regulate access to the data by authorized personnel or programs.

**Audit control.** The system needs to implement a mechanism to record and examine the activities of the system.

**Integrity.** The system need to incorporate mechanisms to both protect the stored data

**Person/Entity authentication.** This requires the system to verify that the identity of the entity accessing the data is correct.



## Use Case Scenario

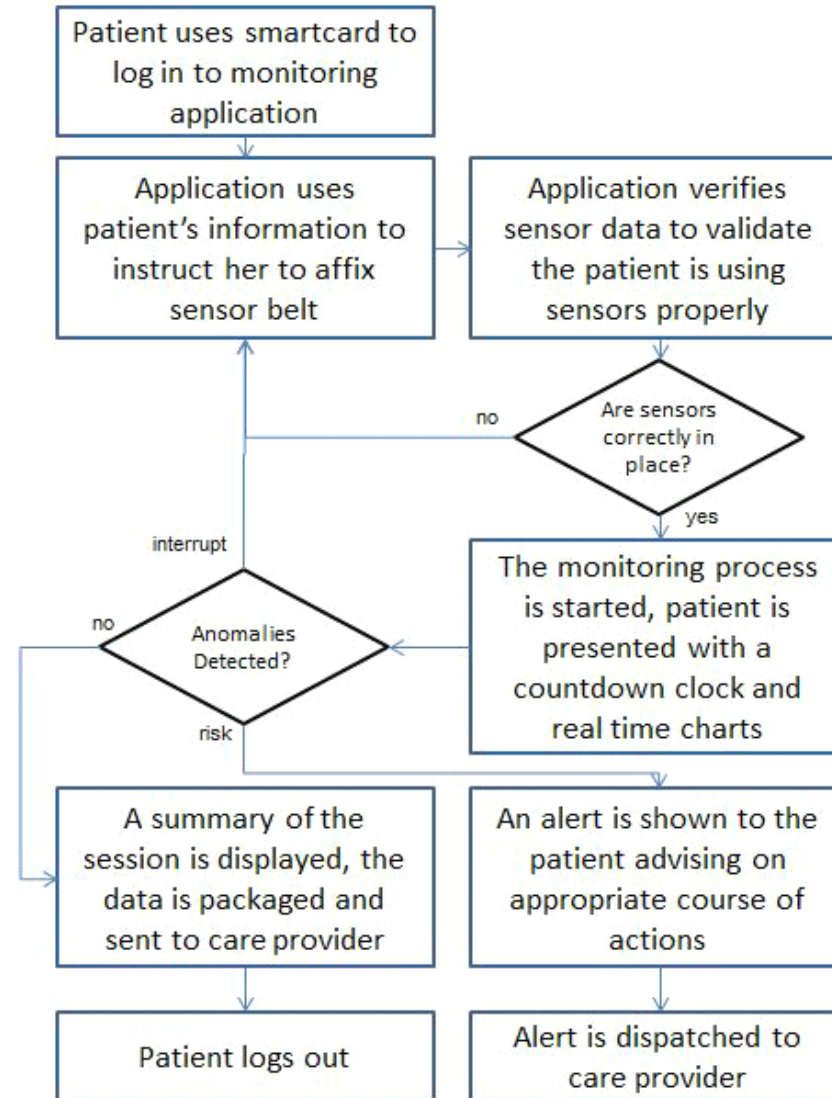



Thank you

Questions

Project Funded by Pennsylvania Department of Health