

Chapter 7

Network Flow

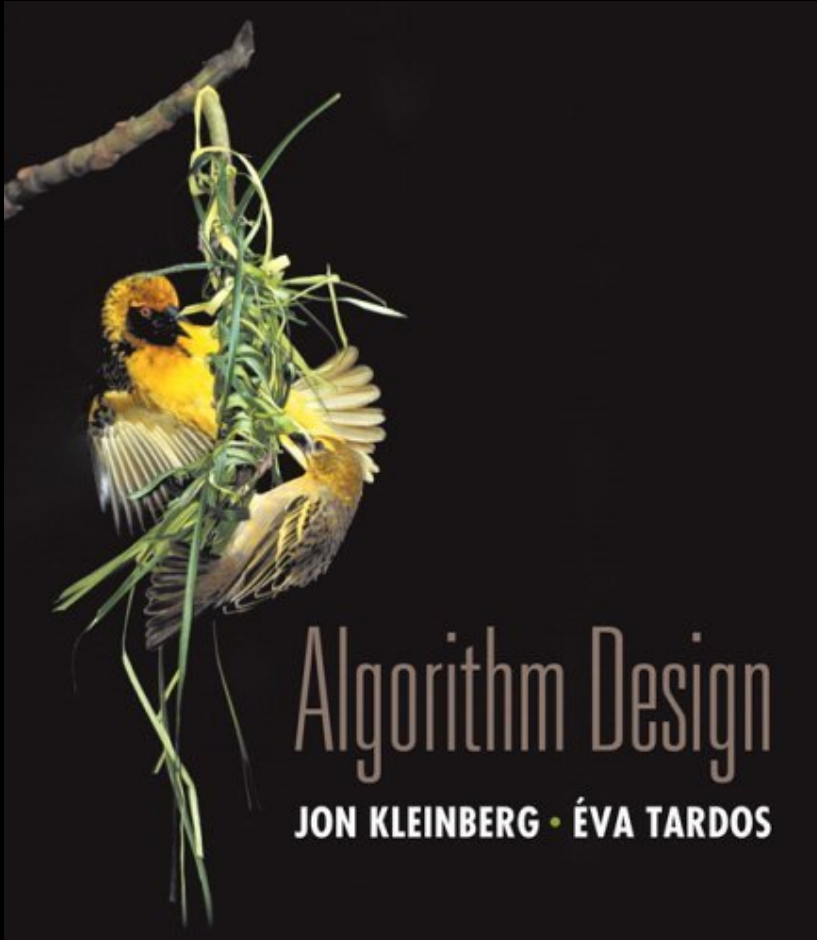

7.5 Bipartite Matching

Matching

Matching.

Input: undirected graph $G = (V, E)$.

$M \subseteq E$ is a **matching** if each node appears in at most one edge in M .

Max matching: find a max cardinality matching.

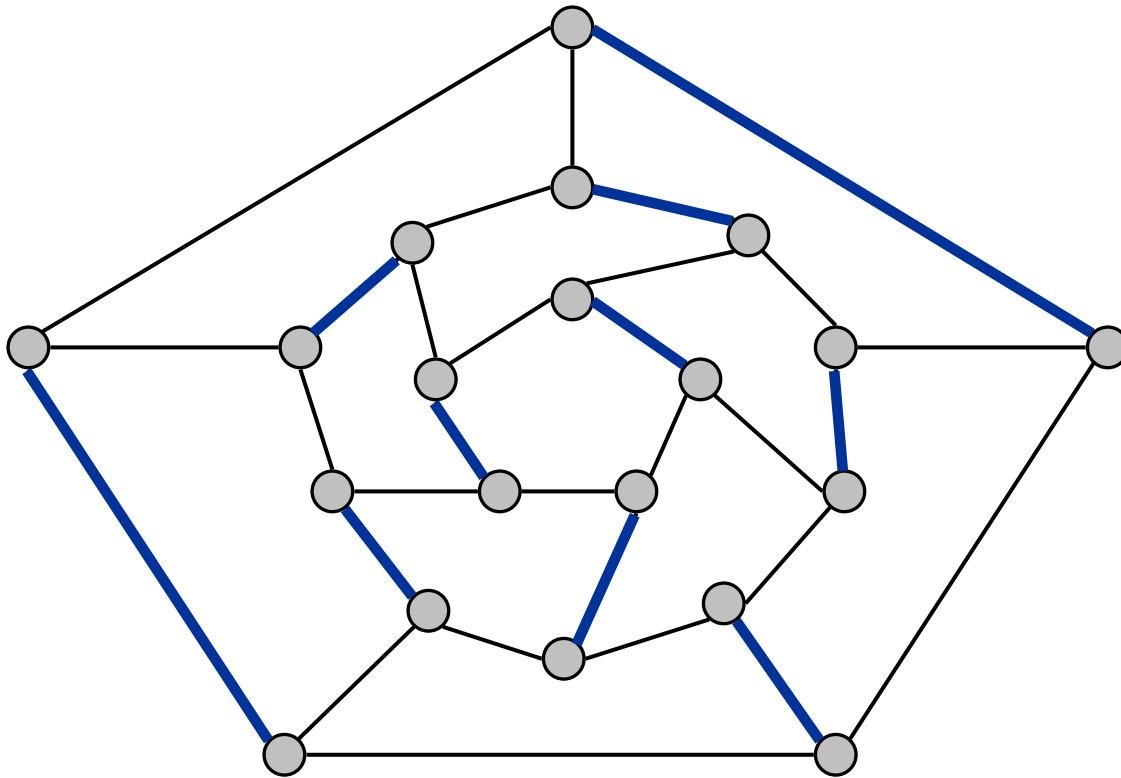

Bipartite Matching

Bipartite matching.

Input: undirected, **bipartite** graph $G = (L \cup R, E)$.

$M \subseteq E$ is a **matching** if each node appears in at one most edge in M .

Max matching: find a max cardinality matching.

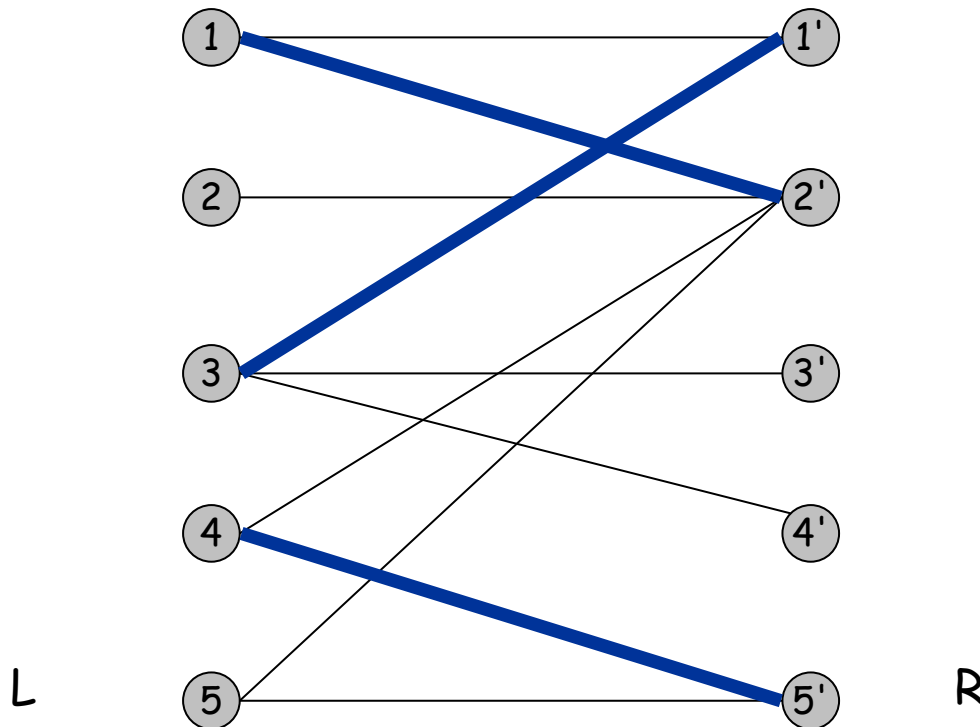

matching
1-2', 3-1', 4-5'

Bipartite Matching

Bipartite matching.

Input: undirected, **bipartite** graph $G = (L \cup R, E)$.

$M \subseteq E$ is a **matching** if each node appears in at most one edge in M .

Max matching: find a max cardinality matching.

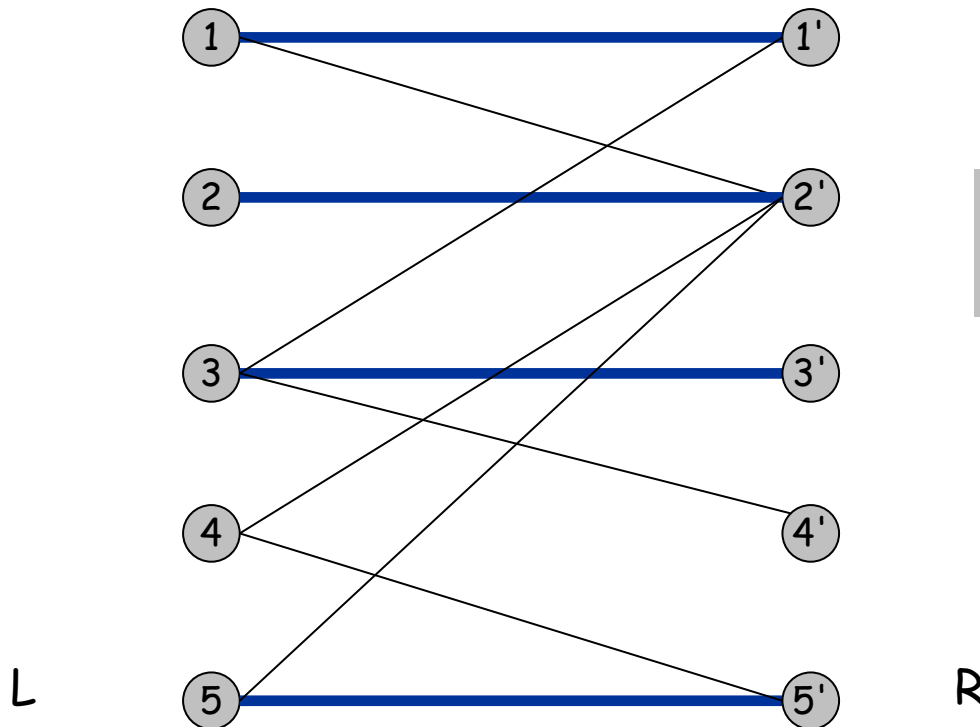

max matching
1-1', 2-2', 3-3' 4-4'

Bipartite Matching

Max flow formulation.

Create digraph $G' = (L \cup R \cup \{s, t\}, E')$.

Direct all edges from L to R and assign infinite (or unit) capacity.

Add source s , and unit capacity edges from s to each node in L .

Add sink t , and unit capacity edges from each node in R to t .

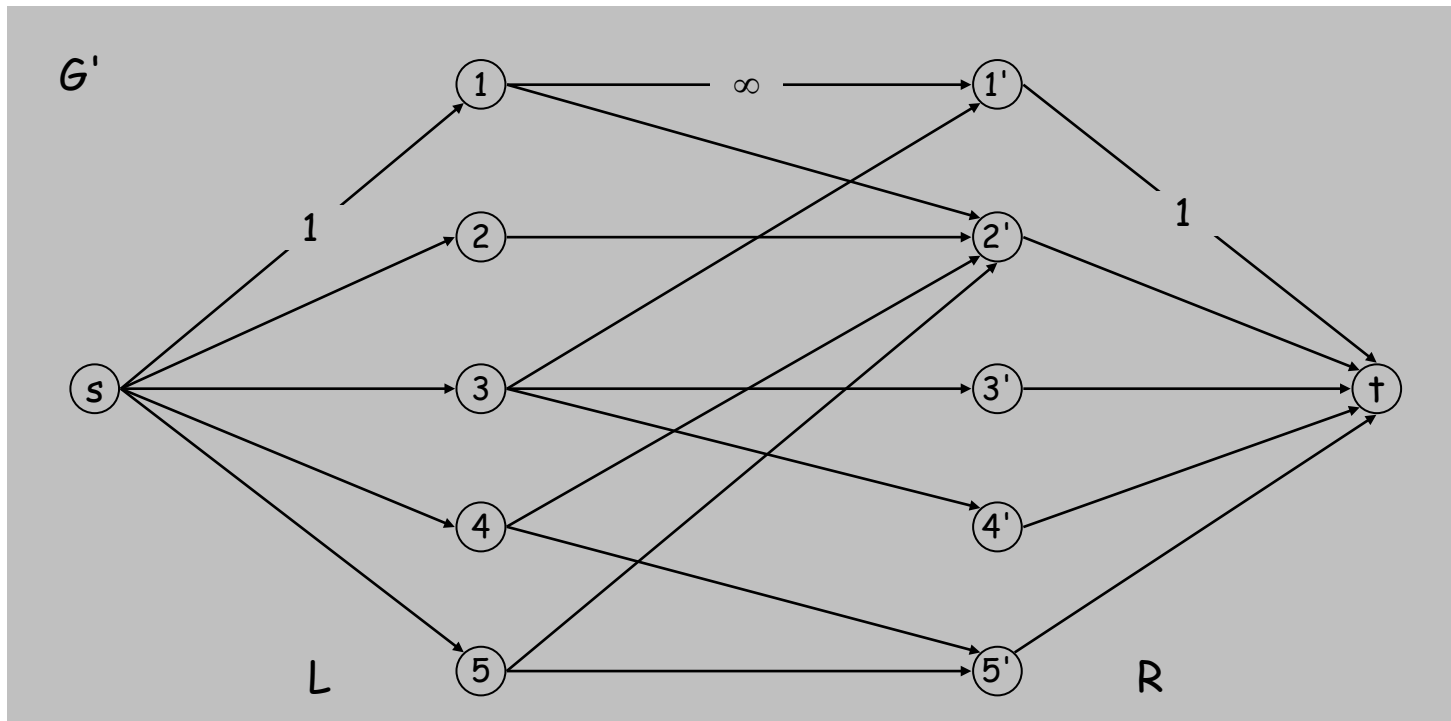

Bipartite Matching: Proof of Correctness

Theorem. Max cardinality matching in G = value of max flow in G' .

Pf. \leq

Given max matching M of cardinality k .

Consider flow f that sends 1 unit along each of k paths.

f is a flow, and has cardinality k . ■

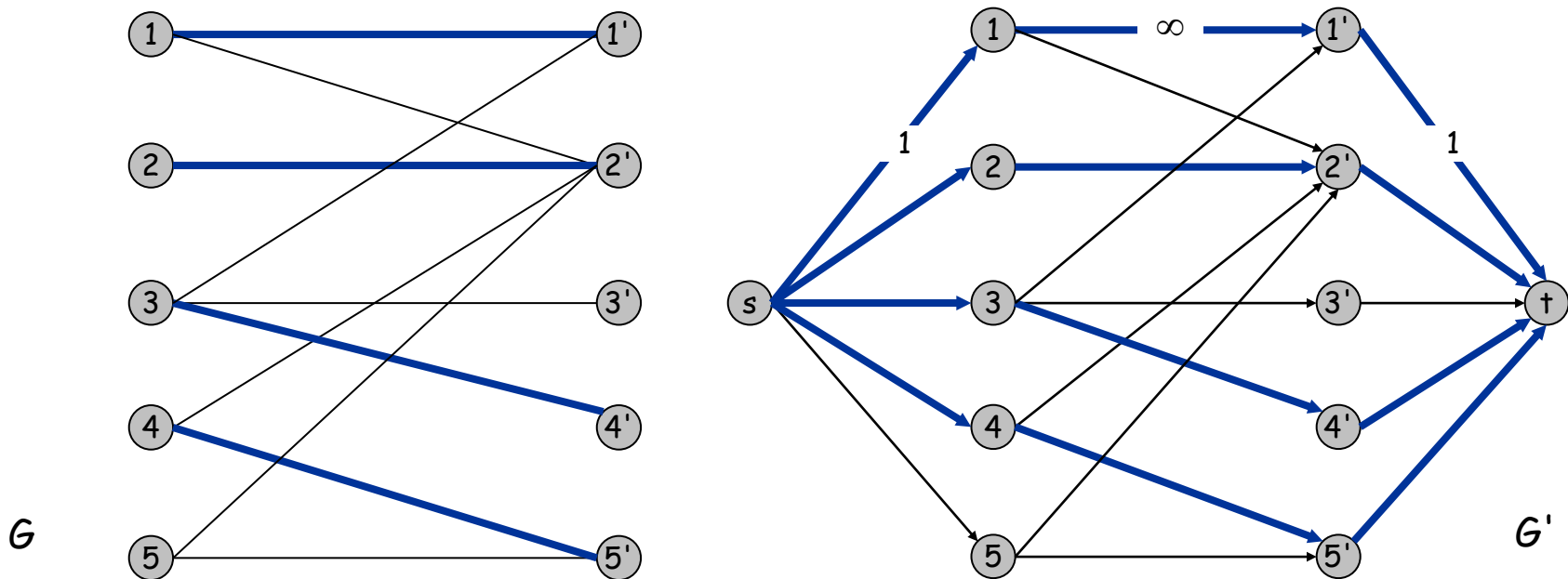

Bipartite Matching: Proof of Correctness

Theorem. Max cardinality matching in G = value of max flow in G' .

Pf. \geq

Let f be a max flow in G' of value k .

Integrality theorem \Rightarrow k is integral and can assume f is 0-1.

Consider M = set of edges from L to R with $f(e) = 1$.

- each node in L and R participates in at most one edge in M
- $|M| = k$: consider cut $(L \cup s, R \cup t)$ ■

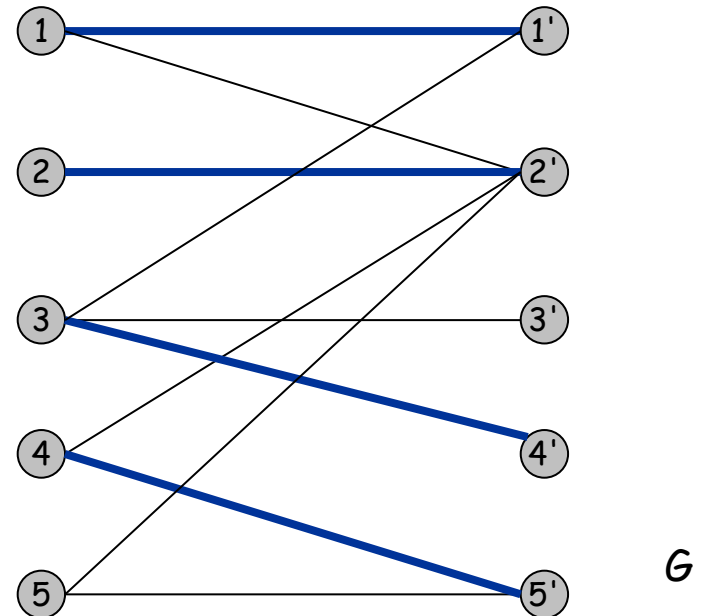
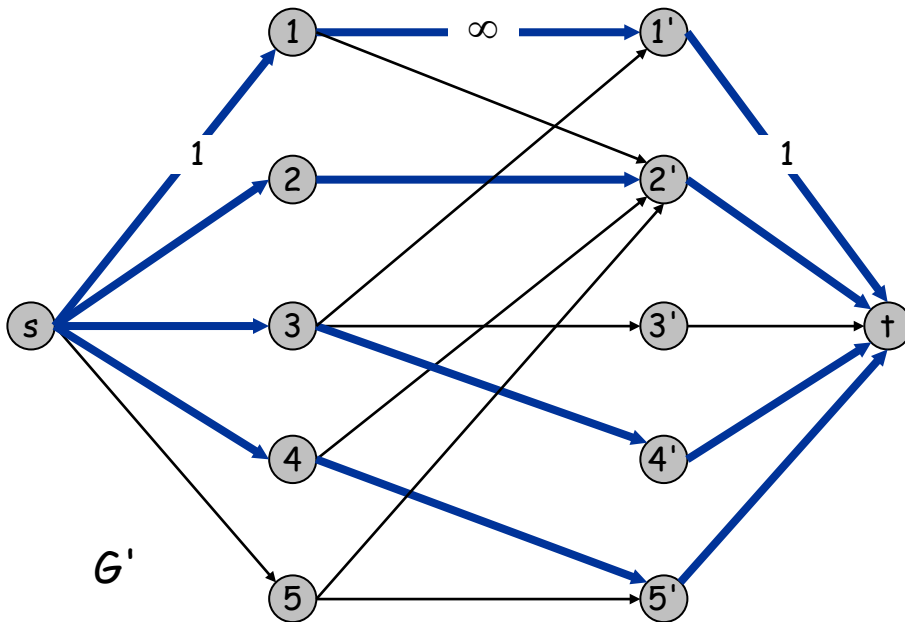

Perfect Matching

Def. A matching $M \subseteq E$ is **perfect** if each node appears in exactly one edge in M .

Q. When does a bipartite graph have a perfect matching?

Structure of bipartite graphs with perfect matchings.

Clearly we must have $|L| = |R|$.

What other conditions are necessary?

What conditions are sufficient?

Perfect Matching

Notation. Let S be a subset of nodes, and let $N(S)$ be the set of nodes adjacent to nodes in S .

Observation. If a bipartite graph $G = (L \cup R, E)$, has a perfect matching, then $|N(S)| \geq |S|$ for all subsets $S \subseteq L$.

Pf. Each node in S has to be matched to a different node in $N(S)$.

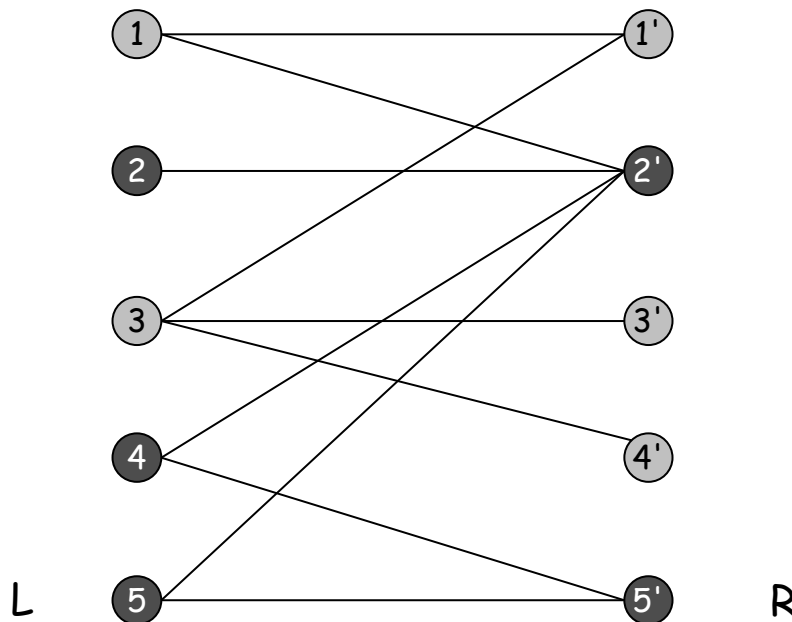

No perfect matching:

$$S = \{ 2, 4, 5 \}$$

$$N(S) = \{ 2', 5' \}.$$

Marriage Theorem

Marriage Theorem. [Frobenius 1917, Hall 1935] Let $G = (L \cup R, E)$ be a bipartite graph with $|L| = |R|$. Then, G has a perfect matching iff $|N(S)| \geq |S|$ for all subsets $S \subseteq L$.

(S is called a *constricted set* if $|S| > |N(S)|$)

Pf. \Rightarrow This was the previous observation.

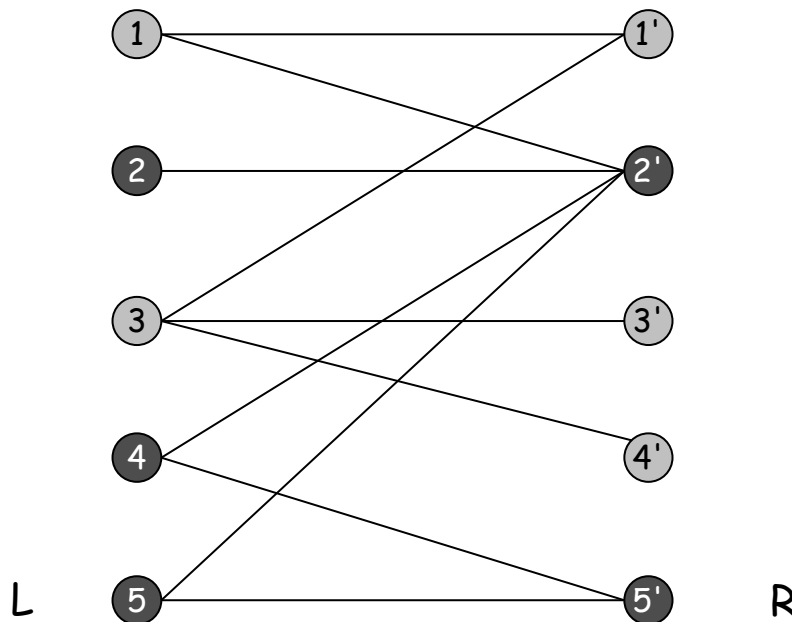

No perfect matching:

$$S = \{ 2, 4, 5 \}$$

$$N(S) = \{ 2', 5' \}.$$

k-Regular Bipartite Graphs

Dancing problem.

Exclusive Ivy league party attended by n men and n women.

Each man knows exactly k women; each woman knows exactly k men.

Acquaintances are mutual.

Is it possible to arrange a dance so that each woman dances with a different man that she knows?

Mathematical reformulation. Does every k -regular bipartite graph have a perfect matching?

Ex. Boolean hypercube.

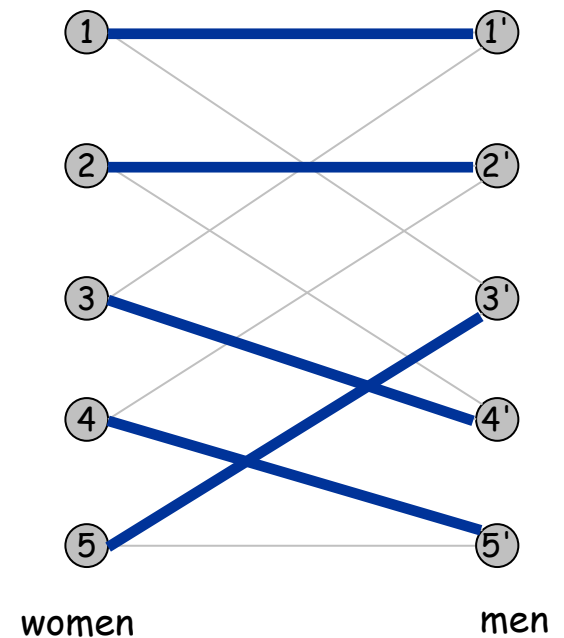

k-Regular Bipartite Graphs Have Perfect Matchings

Theorem. [König 1916, Frobenius 1917] Every k-regular bipartite graph has a perfect matching.

Pf. Size of max matching = value of max flow in G' . Consider flow:

$$f(u, v) = \begin{cases} 1/k & \text{if } (u, v) \in E \\ 1 & \text{if } u = s \text{ or } v = t \\ 0 & \text{otherwise} \end{cases}$$

f is a flow and its value = $n \Rightarrow$ perfect matching. ■

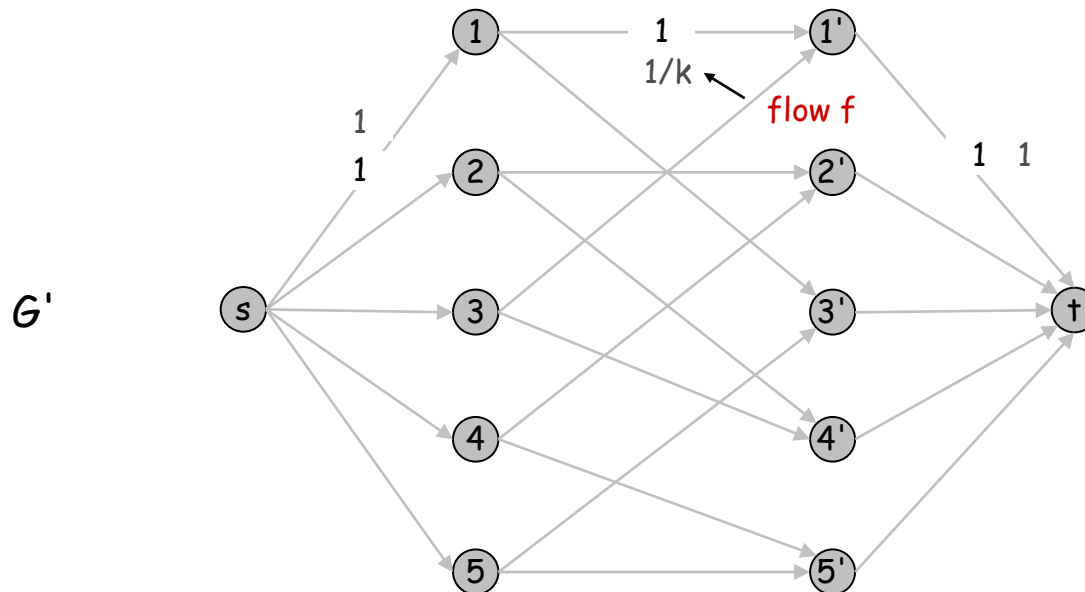

Proof of Marriage Theorem

Pf. \Leftarrow Suppose G does not have a perfect matching.

Formulate as a max flow problem and let (A, B) be min cut in G' .

By max-flow min-cut, $\text{cap}(A, B) < |L|$.

Define $L_A = L \cap A$, $L_B = L \cap B$, $R_A = R \cap A$.

$\text{cap}(A, B) = |L_B| + |R_A|$.

Since min cut can't use ∞ edges: $N(L_A) \subseteq R_A$.

$|N(L_A)| \leq |R_A| = \text{cap}(A, B) - |L_B| < |L| - |L_B| = |L_A|$.

Choose $S = L_A$. \blacksquare

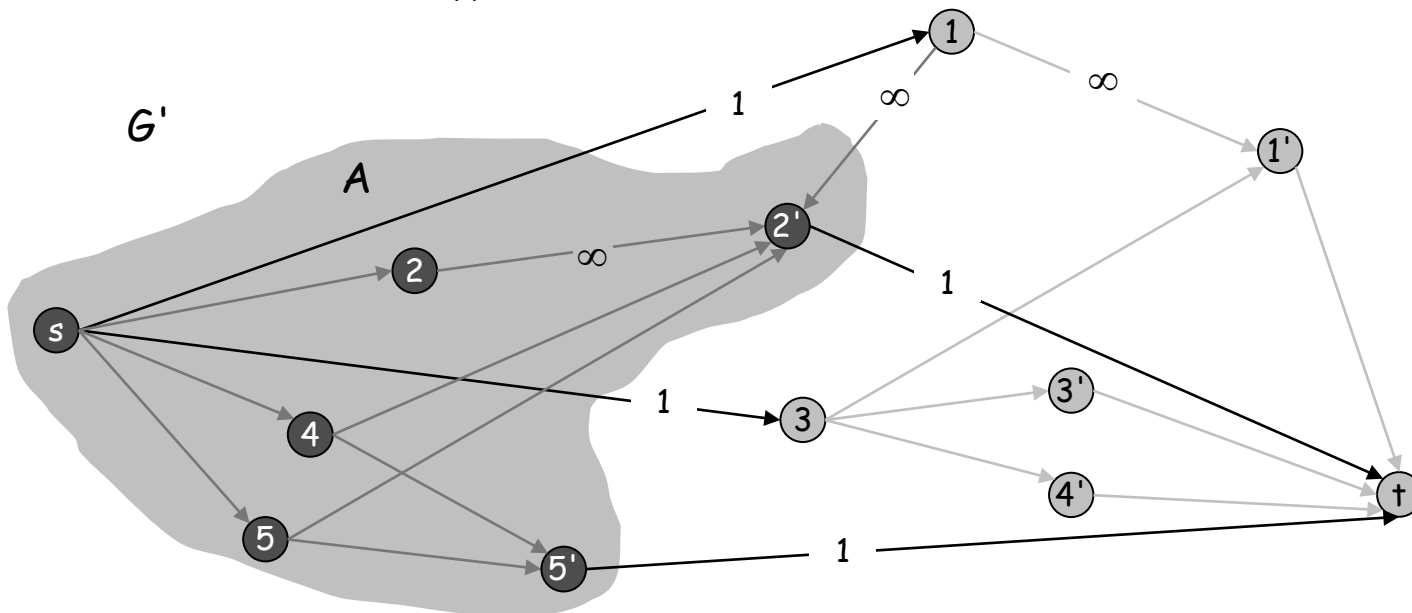

$L_A = \{2, 4, 5\}$
 $L_B = \{1, 3\}$
 $R_A = \{2', 5'\}$
 $N(L_A) = \{2', 5'\}$

Bipartite Matching: Running Time

Which max flow algorithm to use for bipartite matching?

Generic augmenting path: $O(m \text{val}(f^*)) = O(mn)$.

Capacity scaling: $O(m^2 \log C) = O(m^2)$.

Shortest augmenting path: $O(m n^{1/2})$.

Non-bipartite matching.

Structure of non-bipartite graphs is more complicated, but well-understood. [Tutte-Berge, Edmonds-Galai]

Blossom algorithm: $O(n^4)$. [Edmonds 1965]

Best known: $O(m n^{1/2})$. [Micali-Vazirani 1980]

Bipartite Matching with Costs

(Easley/Kleinberg: Networks, Crowds, and Markets)

Economic model

Buyers (females, S) and sellers (males, $N(S)$)

Each buyer has a valuation of each seller

Perfect matching with total maximum valuations among matched pairs
(social welfare)

Can we convince the buyer to buy the items they are allocated?

Economic model (seller asks for a price): Accounting method

Total Payoff of S = Total Valuation of S - Sum of all prices

Optimality of Market-Clearing Prices

A set of market-clearing prices, and a perfect matching in the resulting preferred-seller graph, produces the maximum possible sum of payoffs to all sellers and buyers

(Proposed in 1986 by Demange, Gale, and Sotomayor, but is equivalent to the 1916 result by a Hungarian mathematician.)

Matching Market

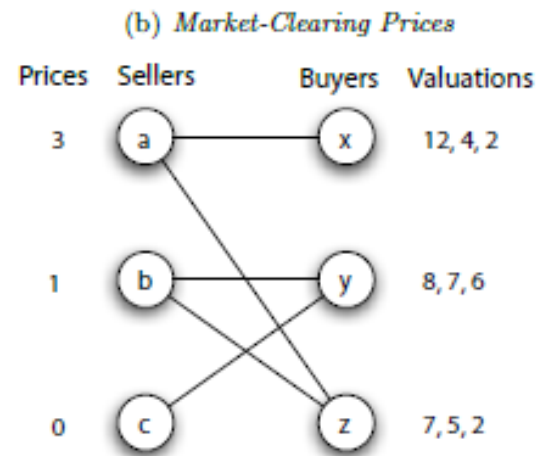
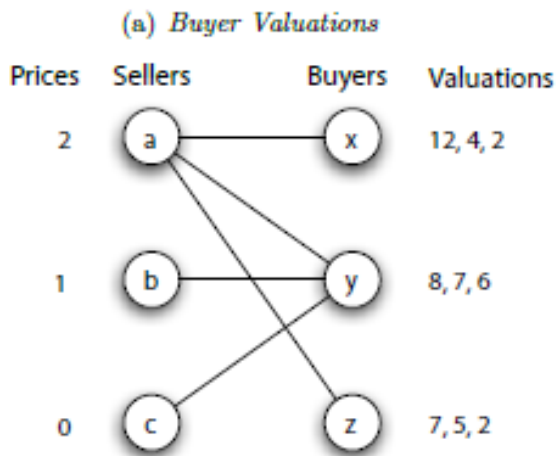
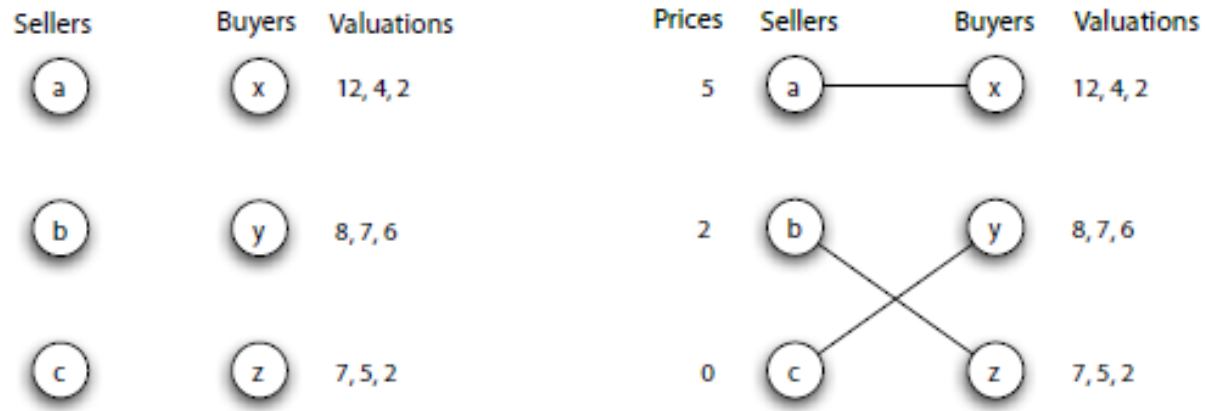

(c) *Prices that Don't Clear the Market*

(d) *Market-Clearing Prices (Tie-Breaking Required)*

Figure 10.5: (a) Three sellers (a , b , and c) and three buyers (x , y , and z). For each buyer node, the valuations for the houses of the respective sellers appear in a list next to the node. (b) Each buyer creates a link to her preferred seller. The resulting set of edges is the preferred-seller graph for this set of prices. (c) The preferred-seller graph for prices 2, 1, 0. (d) The preferred-seller graph for prices 3, 1, 0.

Constructing a Set of Market-Clearing Prices

Auction

At the start of each round, there is a current set of prices, with the smallest one equal 0.

Construct the **preferred-seller graph** and check whether there is a perfect matching.

If there is, then done: the current prices are market-clearing.

If not, find a **constricted set** of buyers, S , and their neighbors $N(S)$.

Each seller in $N(S)$ (simultaneously) raises his price by one unit.

If necessary, reduce the prices: the same amount is subtracted from each price so that the smallest price become zero.

Begin the next round of the auction, using these new prices.

Auction Procedure

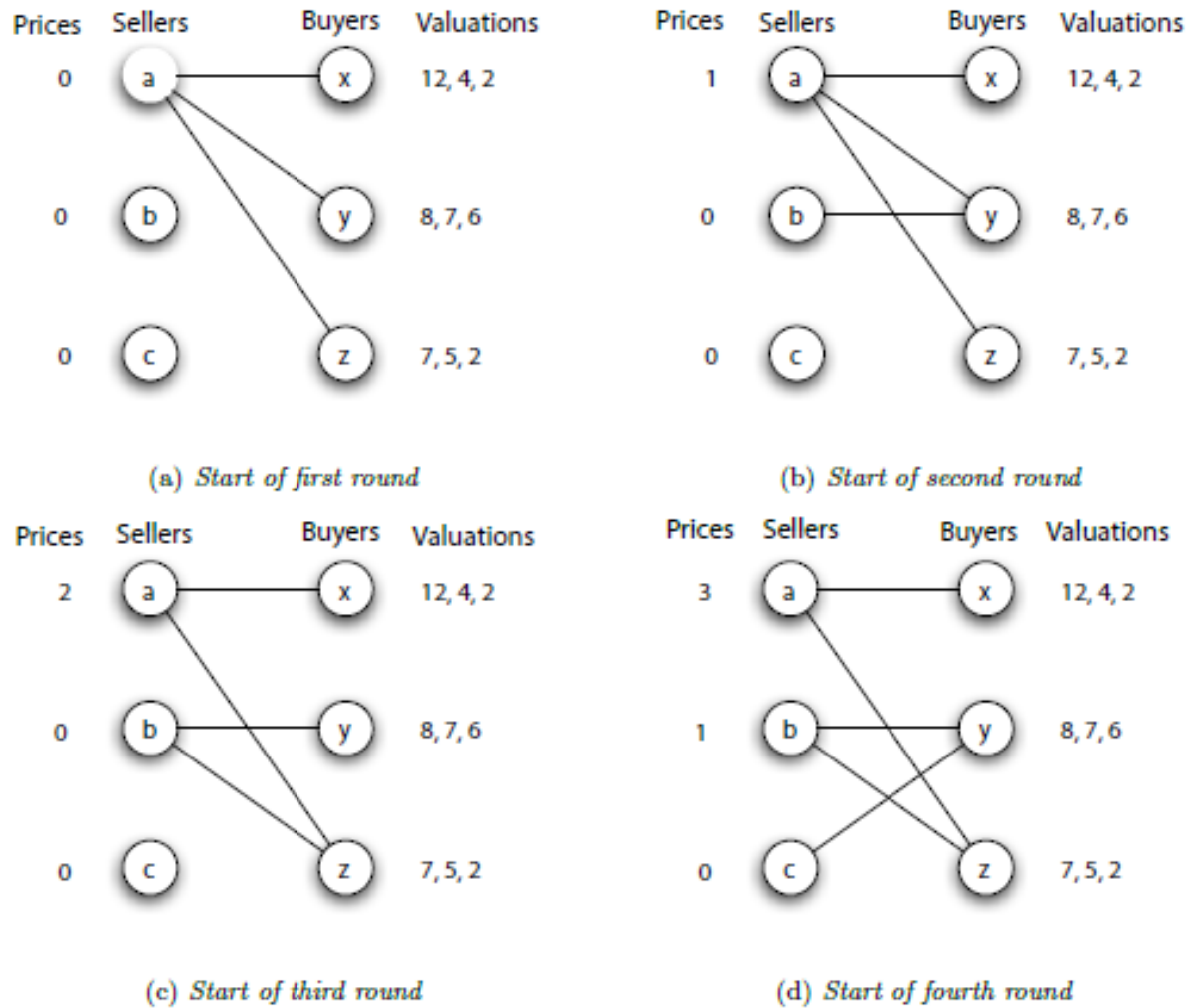
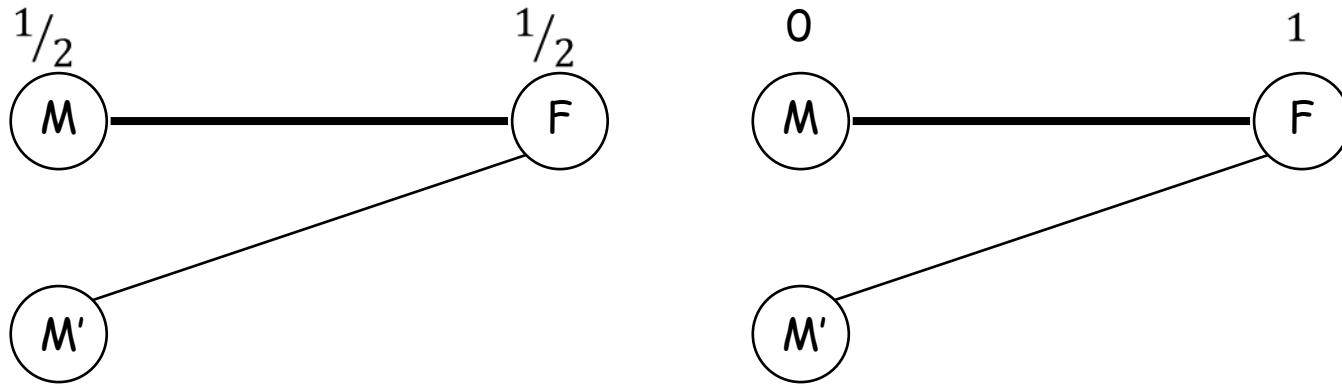
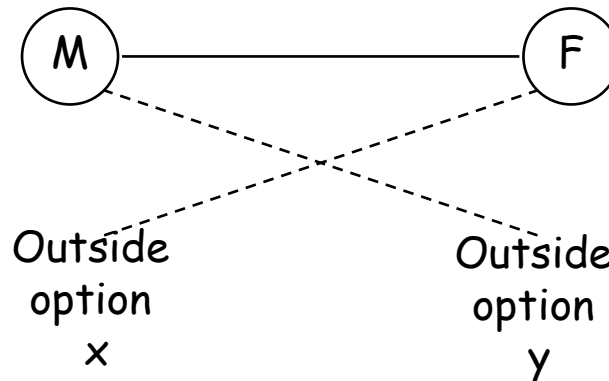

Figure 10.6: The auction procedure applied to the example from Figure 10.5. Each separate picture shows steps (i) and (ii) of successive rounds, in which the preferred-seller graph for that round is constructed.

Stable bargaining and Nash bargaining (Easley/Kleinberg)



Instability: two neighboring nodes not in a pair have a total weight of less than 1



Nash bargaining: surplus: $s=1-x-y$

(assuming $x+y \leq 1$, otherwise, M and F will negotiate on splitting \$1)

M : $x + s/2$ and F : $y + s/2$

Balanced bargaining

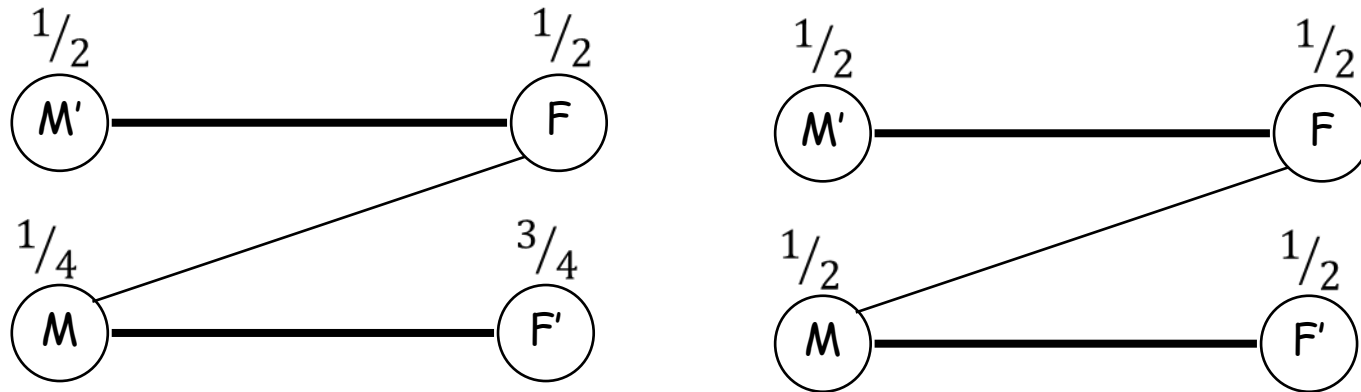

(a) instable, (b) stable, but not balanced, (c) stable and balanced

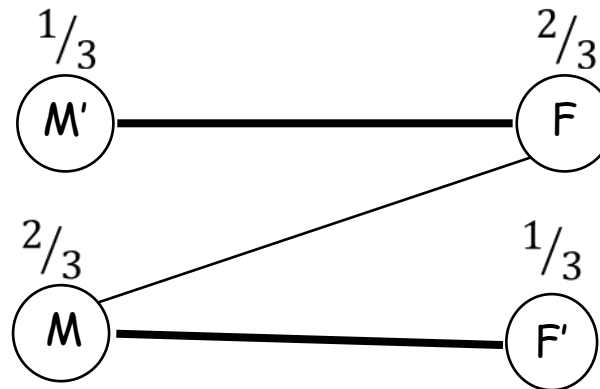

M' outside option: 0, F outside option is $1/3$ (have to pay $2/3$ to win over M)

Balanced: For each edge in the matching, the split of the power/money represents the Nash bargaining, given the best outside options for each node in the network

7.6 Disjoint Paths

Edge Disjoint Paths

Disjoint path problem. Given a digraph $G = (V, E)$ and two nodes s and t , find the max number of edge-disjoint s - t paths.

Def. Two paths are **edge-disjoint** if they have no edge in common.

Ex: communication networks.

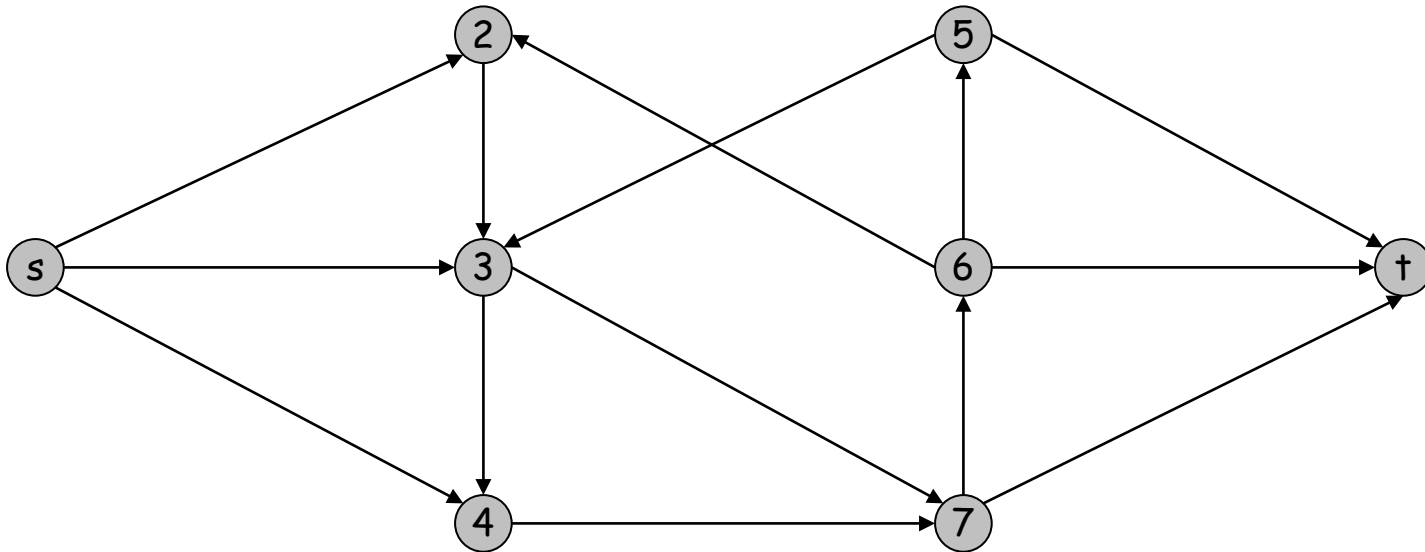

Edge Disjoint Paths

Disjoint path problem. Given a digraph $G = (V, E)$ and two nodes s and t , find the max number of edge-disjoint s - t paths.

Def. Two paths are **edge-disjoint** if they have no edge in common.

Ex: communication networks.

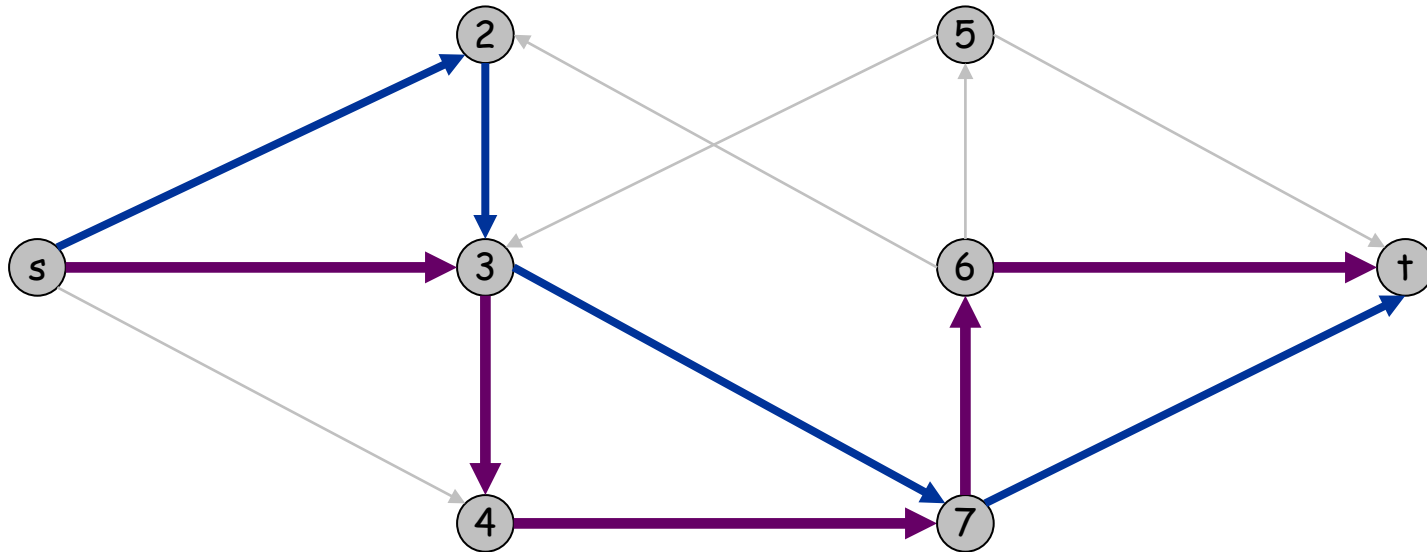

Edge Disjoint Paths

Max flow formulation: assign unit capacity to every edge.

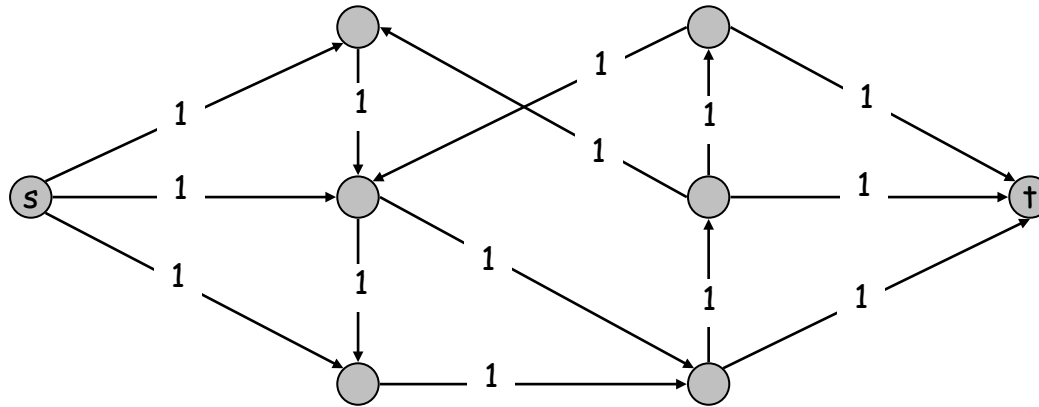

Theorem. Max number edge-disjoint s - t paths equals max flow value.

Pf. \leq

Suppose there are k edge-disjoint paths P_1, \dots, P_k .

Set $f(e) = 1$ if e participates in some path P_i ; else set $f(e) = 0$.

Since paths are edge-disjoint, f is a flow of value k . ■

Edge Disjoint Paths

Max flow formulation: assign unit capacity to every edge.

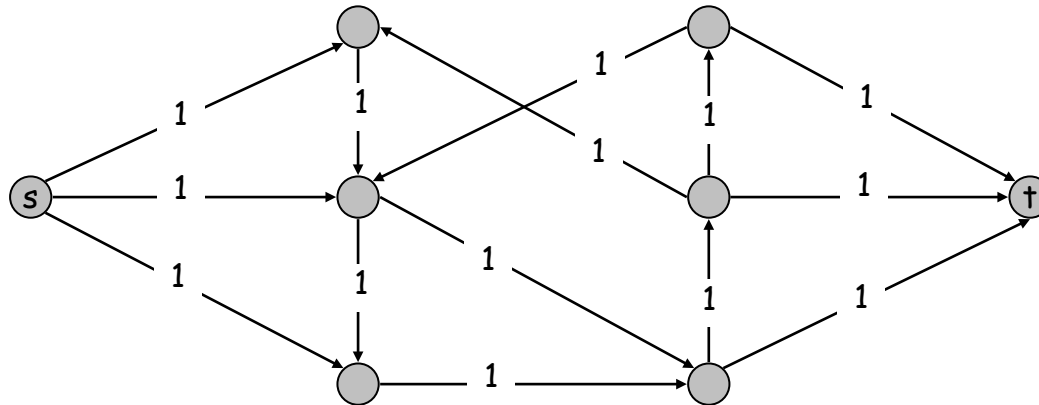

Theorem. Max number edge-disjoint s - t paths equals max flow value.

Pf. \geq

Suppose max flow value is k .

Integrality theorem \Rightarrow there exists 0-1 flow f of value k .

Consider edge (s, u) with $f(s, u) = 1$.

- by conservation, there exists an edge (u, v) with $f(u, v) = 1$
- continue until reach t , always choosing a new edge

Produces k (not necessarily simple) edge-disjoint paths. ■

↙ can eliminate cycles to get simple paths if desired

Network Connectivity

Network connectivity. Given a digraph $G = (V, E)$ and two nodes s and t , find min number of edges whose removal disconnects t from s .

Def. A set of edges $F \subseteq E$ **disconnects t from s** if every s - t path uses at least one edge in F .

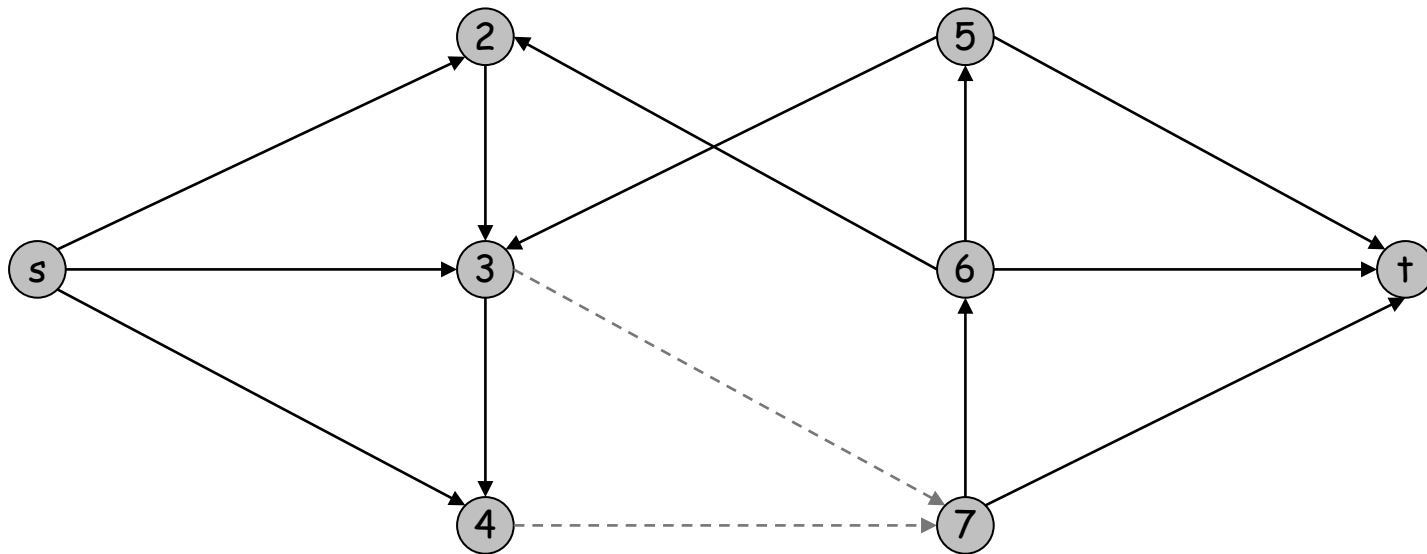

Edge Disjoint Paths and Network Connectivity

Theorem. [Menger 1927] The max number of edge-disjoint s - t paths is equal to the min number of edges whose removal disconnects t from s .

Pf. \leq

Suppose the removal of $F \subseteq E$ disconnects t from s , and $|F| = k$.

Every s - t path uses at least one edge in F .

Hence, the number of edge-disjoint paths is at most k . ■

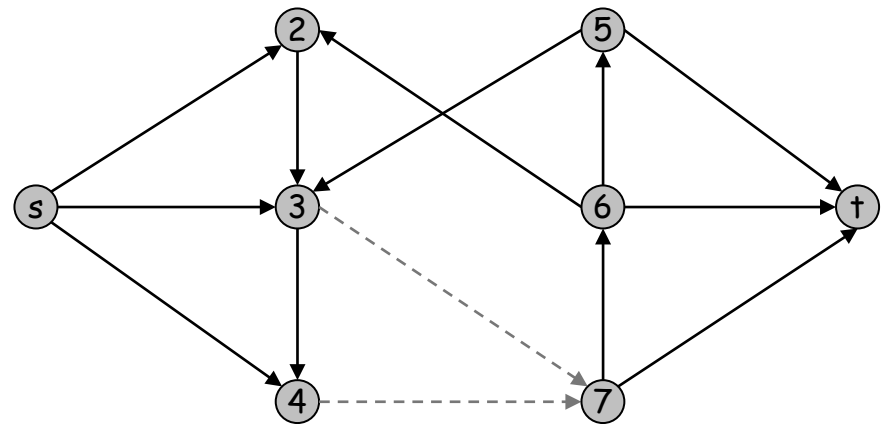
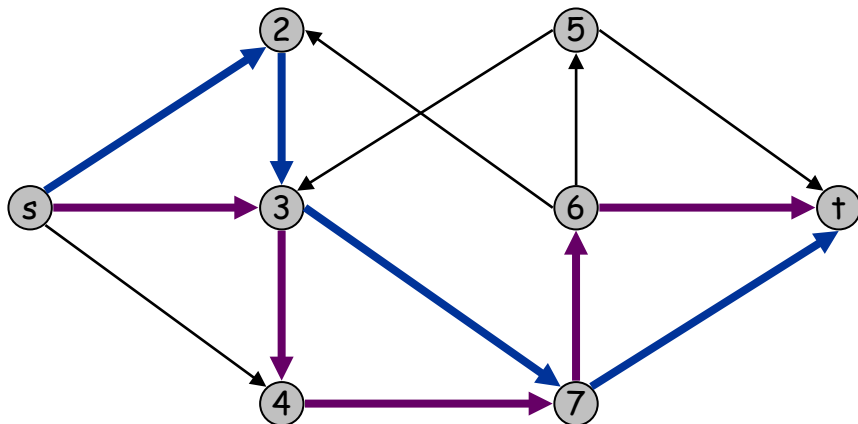

Disjoint Paths and Network Connectivity

Theorem. [Menger 1927] The max number of edge-disjoint s - t paths is equal to the min number of edges whose removal disconnects t from s .

Pf. \geq

Suppose max number of edge-disjoint paths is k .

Then max flow value is k .

Max-flow min-cut \Rightarrow cut (A, B) of capacity k .

Let F be set of edges going from A to B .

$|F| = k$ and disconnects t from s . ■

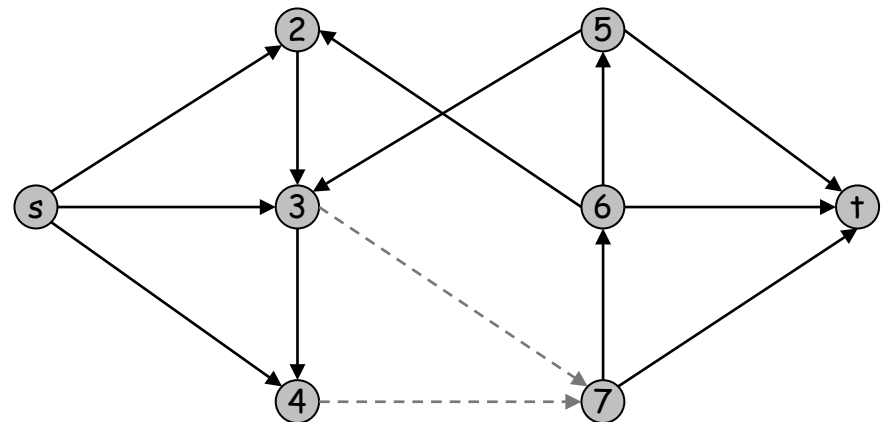
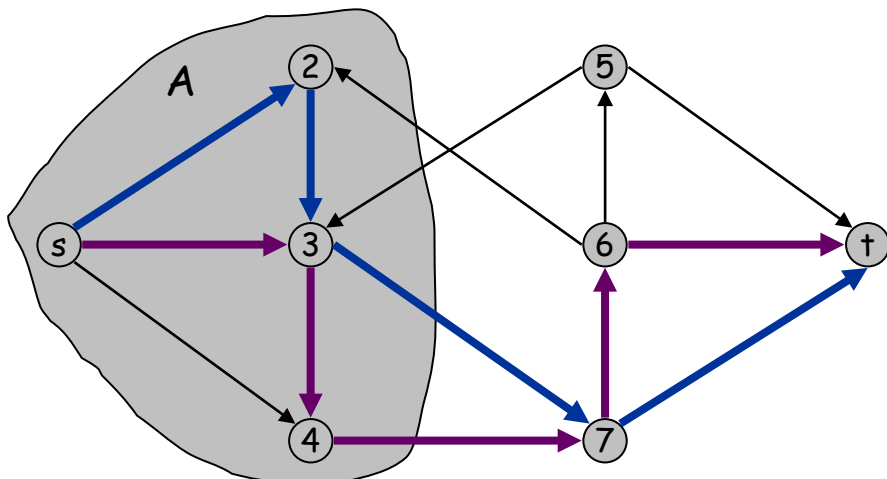

7.7 Extensions to Max Flow

Circulation with Demands

Circulation with demands.

Directed graph $G = (V, E)$.

Edge capacities $c(e)$, $e \in E$.

Node supply and demands $d(v)$, $v \in V$.

↑
demand if $d(v) > 0$; supply if $d(v) < 0$; transshipment if $d(v) = 0$

Def. A **circulation** is a function that satisfies:

For each $e \in E$: $0 \leq f(e) \leq c(e)$ (capacity)

For each $v \in V$: $\sum_{e \text{ in to } v} f(e) - \sum_{e \text{ out of } v} f(e) = d(v)$ (conservation)

Circulation problem: given (V, E, c, d) , does there exist a circulation?

Circulation with Demands

Necessary condition: sum of supplies = sum of demands.

$$\sum_{v:d(v)>0} d(v) = \sum_{v:d(v)<0} -d(v) =: D$$

Pf. Sum conservation constraints for every demand node v .

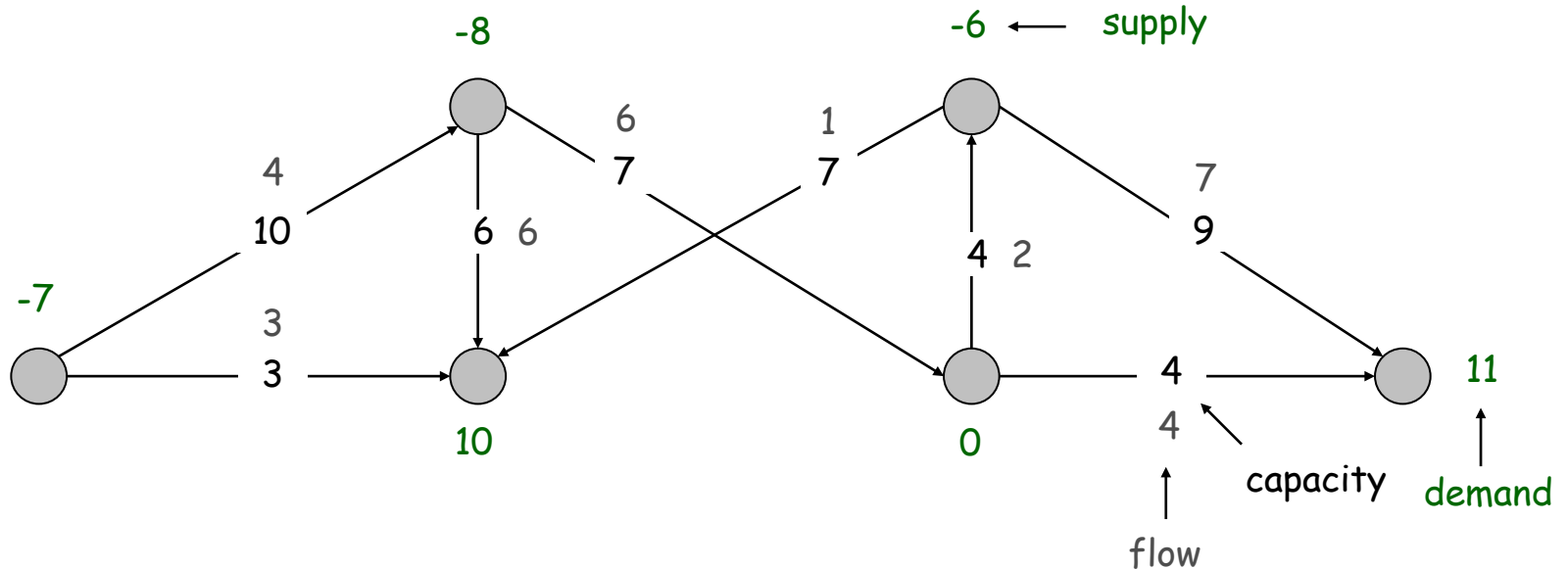

Circulation with Demands

Max flow formulation.

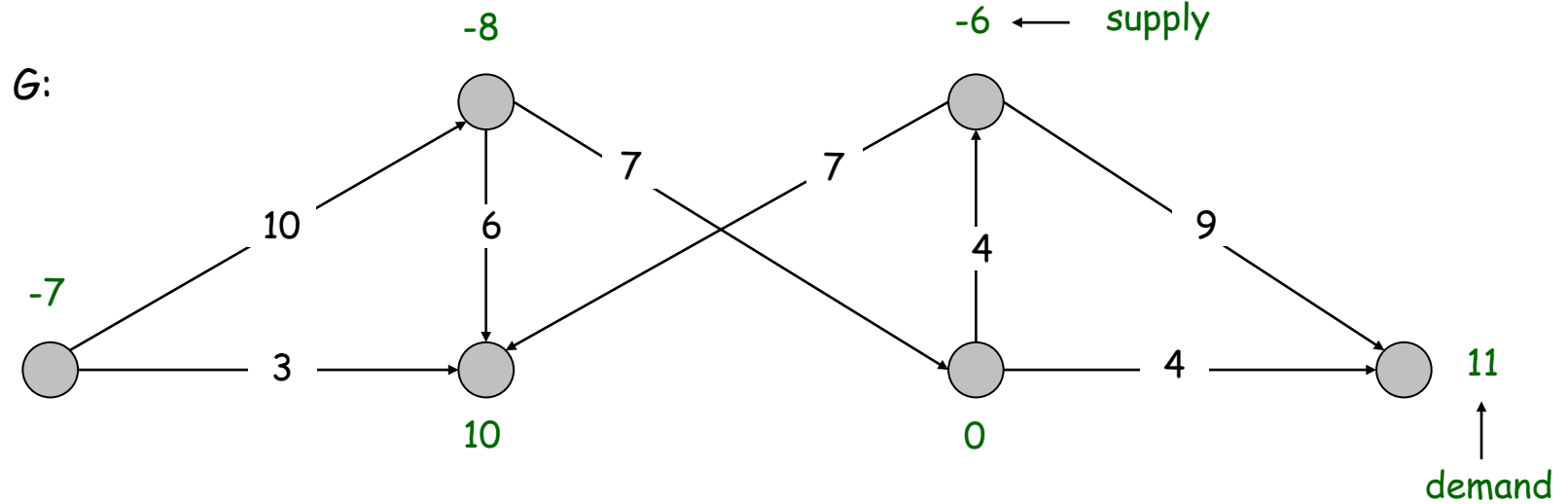

Circulation with Demands

Max flow formulation.

Add new source s and sink t .

For each v with $d(v) < 0$, add edge (s, v) with capacity $-d(v)$.

For each v with $d(v) > 0$, add edge (v, t) with capacity $d(v)$.

Claim: G has circulation iff G' has max flow of value D .

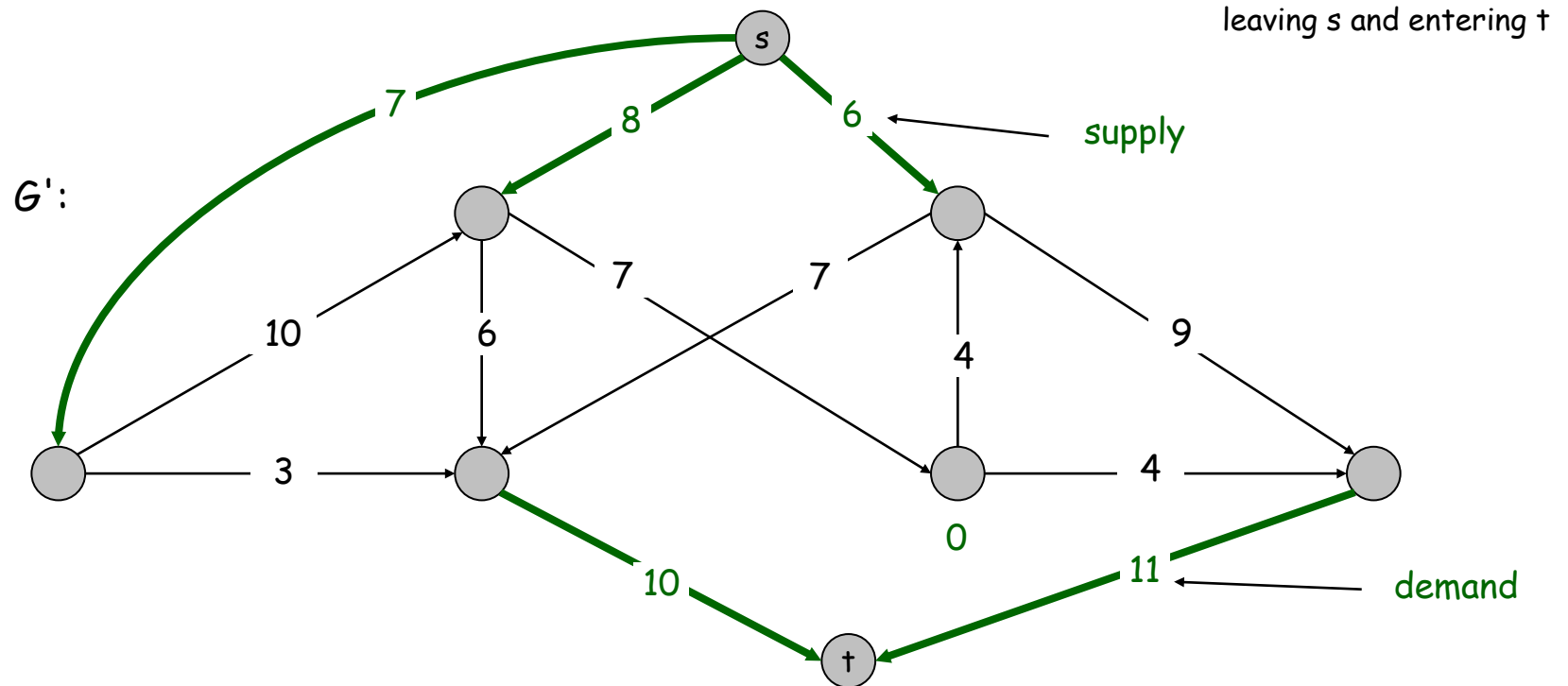

Circulation with Demands

Integrality theorem. If all capacities and demands are integers, and there exists a circulation, then there exists one that is integer-valued.

Pf. Follows from max flow formulation and integrality theorem for max flow.

Characterization. Given (V, E, c, d) , there does **not** exist a circulation iff there exists a node partition (A, B) such that $\sum_{v \in B} d_v > \text{cap}(A, B)$

Pf idea. Look at min cut in G' .

↑
demand by nodes in B exceeds supply
of nodes in B plus max capacity of
edges going from A to B

Circulation with Demands and Lower Bounds

Feasible circulation.

Directed graph $G = (V, E)$.

Edge capacities $c(e)$ and lower bounds $\ell(e)$, $e \in E$.

Node supply and demands $d(v)$, $v \in V$.

Def. A **circulation** is a function that satisfies:

For each $e \in E$: $\ell(e) \leq f(e) \leq c(e)$ (capacity)

For each $v \in V$: $\sum_{e \text{ in to } v} f(e) - \sum_{e \text{ out of } v} f(e) = d(v)$ (conservation)

Circulation problem with lower bounds. Given (V, E, ℓ, c, d) , does there exist a circulation?

Circulation with Demands and Lower Bounds

Idea. Model lower bounds with demands.

Send $\ell(e)$ units of flow along edge e .

Update demands of both endpoints.

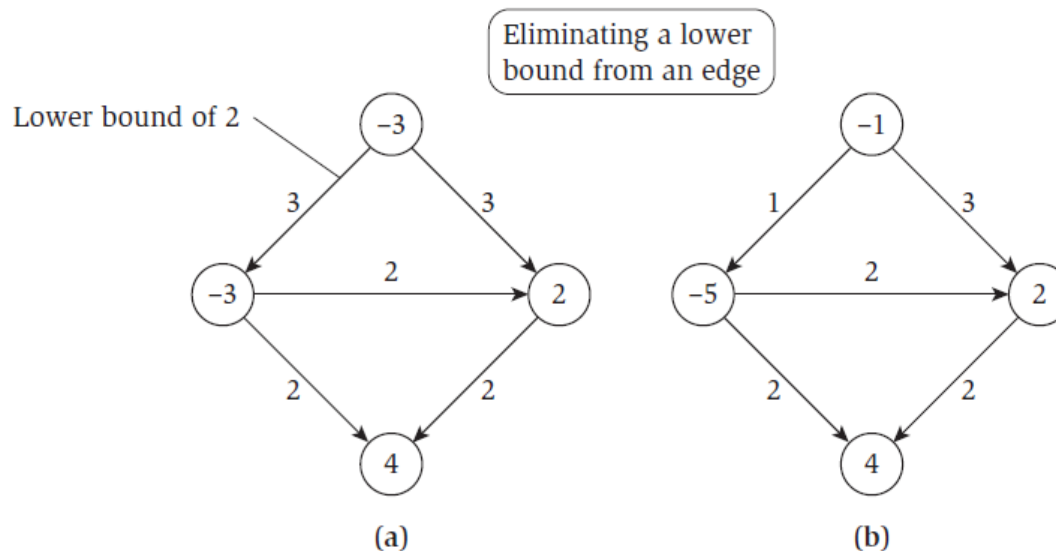
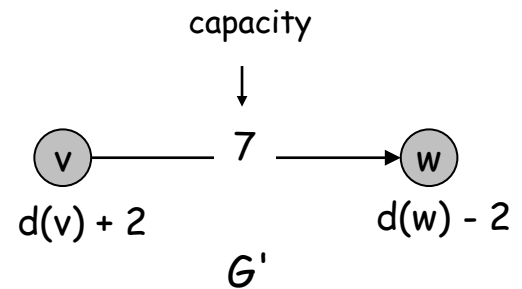
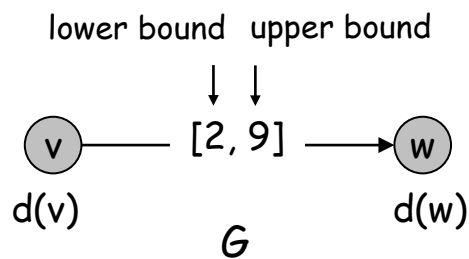

Circulation with Demands and Lower Bounds

Theorem. There exists a circulation in G iff there exists a circulation in G' . If all demands, capacities, and lower bounds in G are integers, then there is a circulation in G that is integer-valued.

Pf sketch. $f(e)$ is a circulation in G iff $f'(e) = f(e) - \ell(e)$ is a circulation in G' .

7.8 Survey Design

Survey Design

Survey design.

one survey question per product



Design survey asking n_1 consumers about n_2 products.

Can only survey consumer i about product j if they own it.

Ask consumer i between c_i and c_i' questions.

Ask between p_j and p_j' consumers about product j .

Goal. Design a survey that meets these specs, if possible.

Bipartite perfect matching. Special case when $c_i = c_i' = p_j = p_j' = 1$.

Survey Design

Algorithm. Formulate as a circulation problem with lower bounds.
Include an edge (i, j) if consumer j owns product i .
Integer circulation \Leftrightarrow feasible survey design.

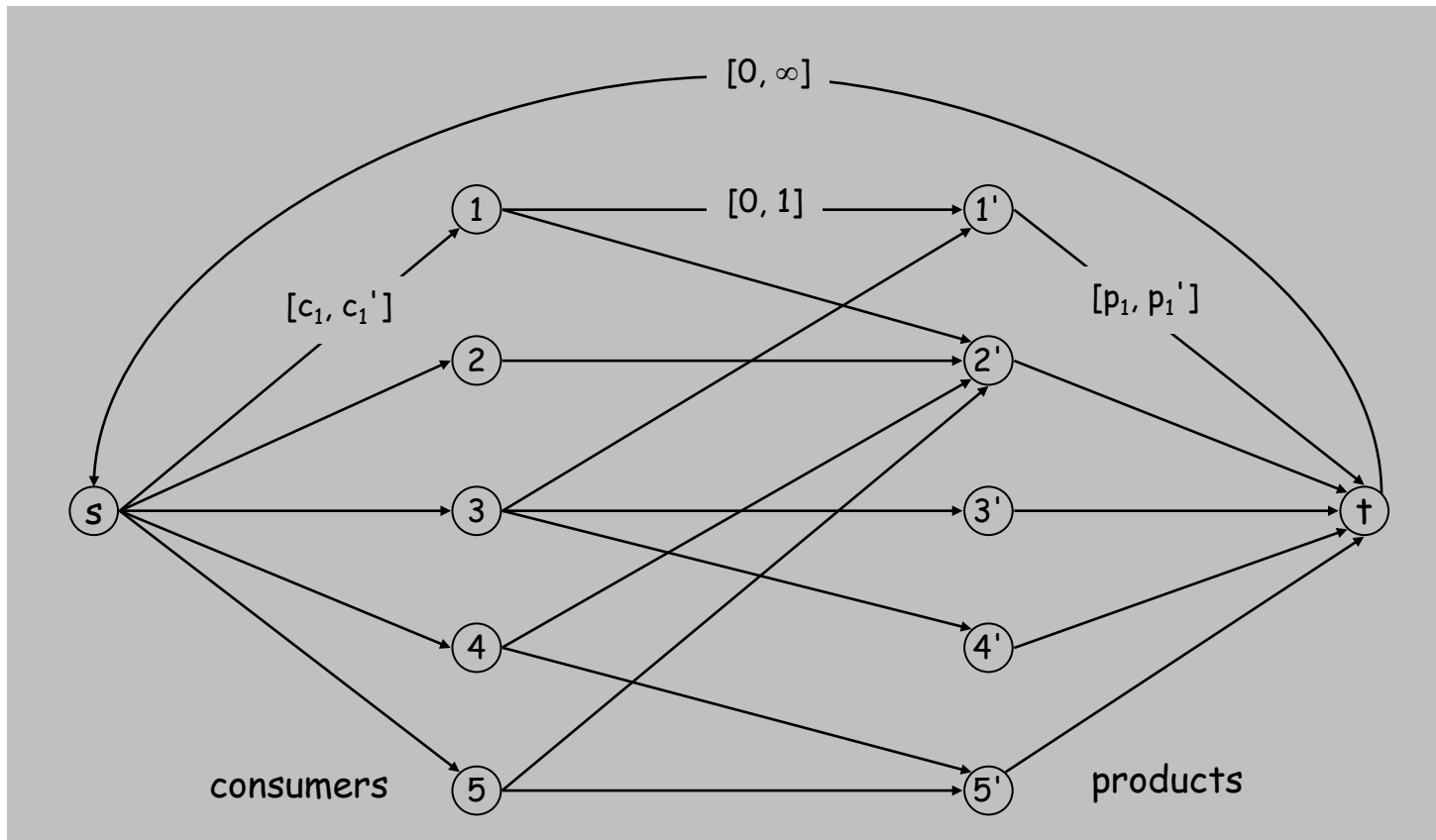

Airline Schedule: k planes schedule

Each edge has a capacity of 1

Solid edge has a **lower bound** of 1 (must use)

s has -k (k planes) and t has k

For each flight (u, v), there is an edge (s, u) and another (v, t)

There is one additional edge (s, t) with k (do not need to use up all)

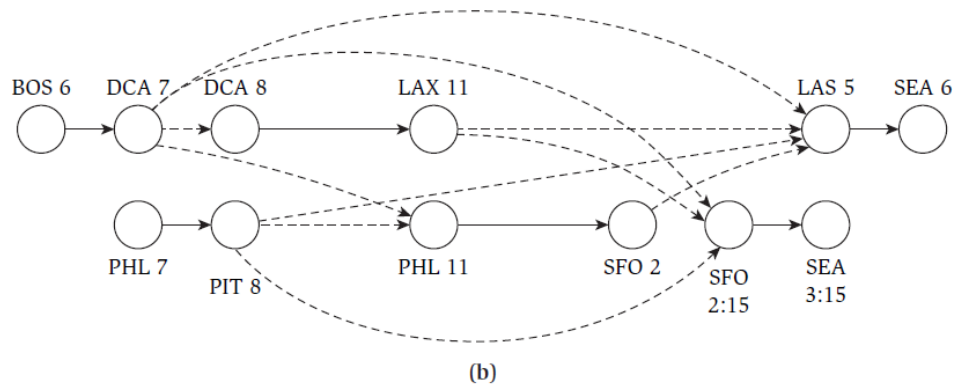
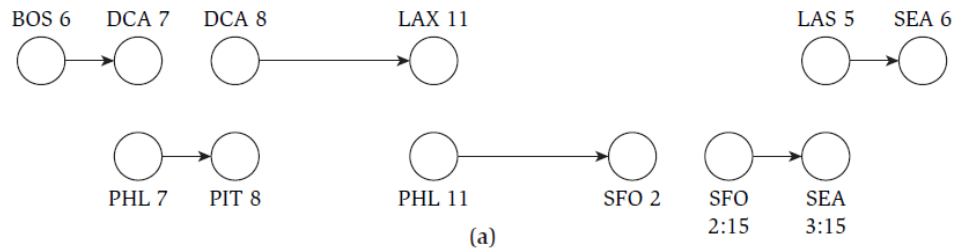

7.10 Image Segmentation

Image Segmentation

Image segmentation.

Central problem in image processing.

Divide image into coherent regions.

Ex: Three people standing in front of complex background scene.
Identify each person as a coherent object.

Image Segmentation

Foreground / background segmentation.

Label each pixel in picture as belonging to foreground or background.

V = set of pixels, E = pairs of neighboring pixels.

$a_i \geq 0$ is likelihood pixel i in foreground.

$b_i \geq 0$ is likelihood pixel i in background.

$p_{ij} \geq 0$ is separation penalty for labeling one of i and j as foreground, and the other as background.

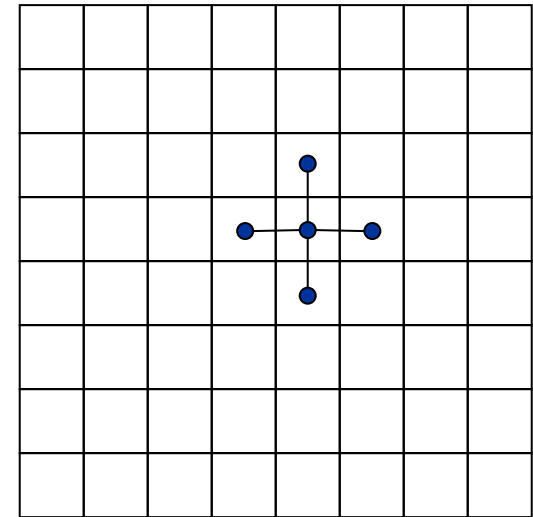

Goals.

Accuracy: if $a_i > b_i$ in isolation, prefer to label i in foreground.

Smoothness: if many neighbors of i are labeled foreground, we should be inclined to label i as foreground.

Find partition (A, B) that maximizes:

$$\sum_{i \in A} a_i + \sum_{j \in B} b_j - \sum_{\substack{(i,j) \in E \\ |A \cap \{i,j\}| = 1}} p_{ij}$$

↗
↘
 foreground background

Image Segmentation

Formulate as min cut problem.

Maximization.

No source or sink.

Undirected graph.

Turn into minimization problem.

$$\text{Maximizing } \sum_{i \in A} a_i + \sum_{j \in B} b_j - \sum_{\substack{(i,j) \in E \\ |A \cap \{i,j\}|=1}} p_{ij}$$

$$\text{is equivalent to minimizing } \underbrace{\left(\sum_{i \in V} a_i + \sum_{j \in V} b_j \right)}_{\text{a constant}} - \sum_{i \in A} a_i - \sum_{j \in B} b_j + \sum_{\substack{(i,j) \in E \\ |A \cap \{i,j\}|=1}} p_{ij}$$

or alternatively

$$\sum_{j \in B} a_j + \sum_{i \in A} b_i + \sum_{\substack{(i,j) \in E \\ |A \cap \{i,j\}|=1}} p_{ij}$$

Image Segmentation

Formulate as min cut problem.

$$G' = (V', E').$$

Add source to correspond to foreground;

add sink to correspond to background

Use two anti-parallel edges instead of undirected edge.

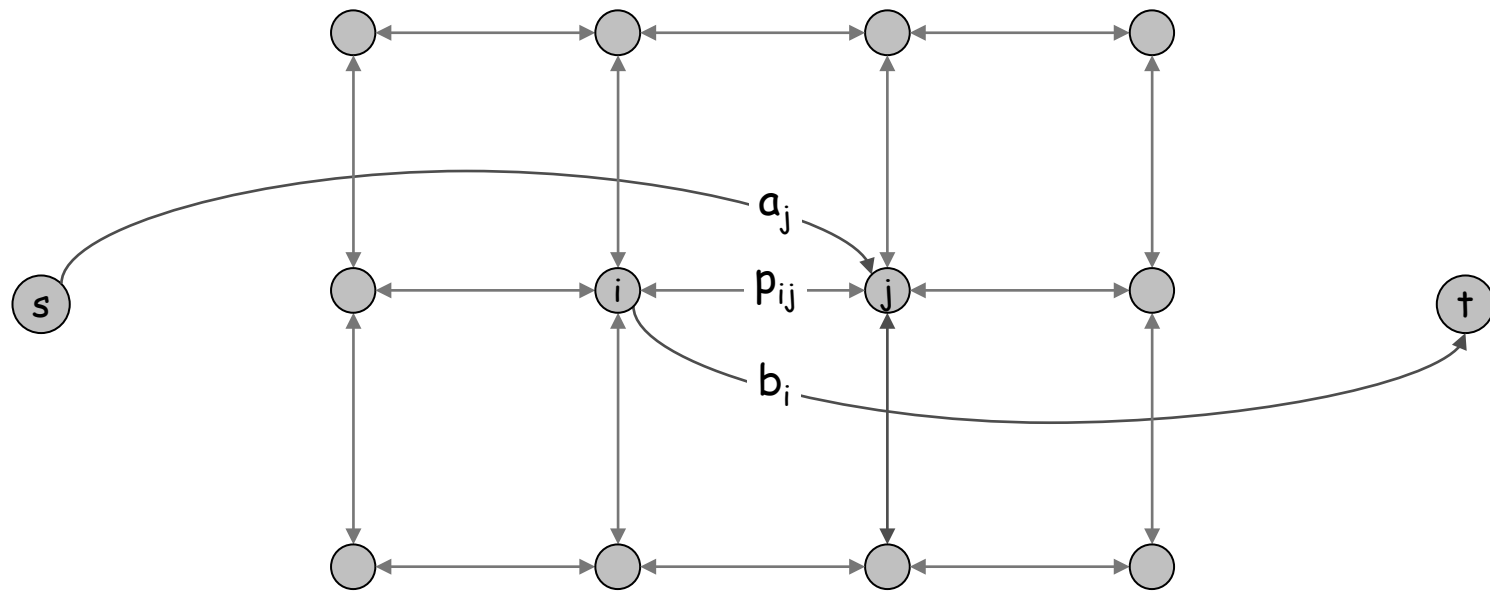
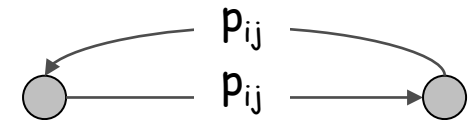
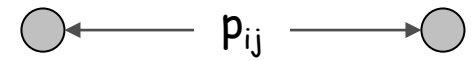

G'

Image Segmentation

Consider min cut (A, B) in G' .

A = foreground.

$$\text{cap}(A, B) = \sum_{j \in B} a_j + \sum_{i \in A} b_i + \sum_{\substack{(i,j) \in E \\ i \in A, j \in B}} p_{ij}$$

← if i and j on different sides, p_{ij} counted exactly once

Precisely the quantity we want to minimize.

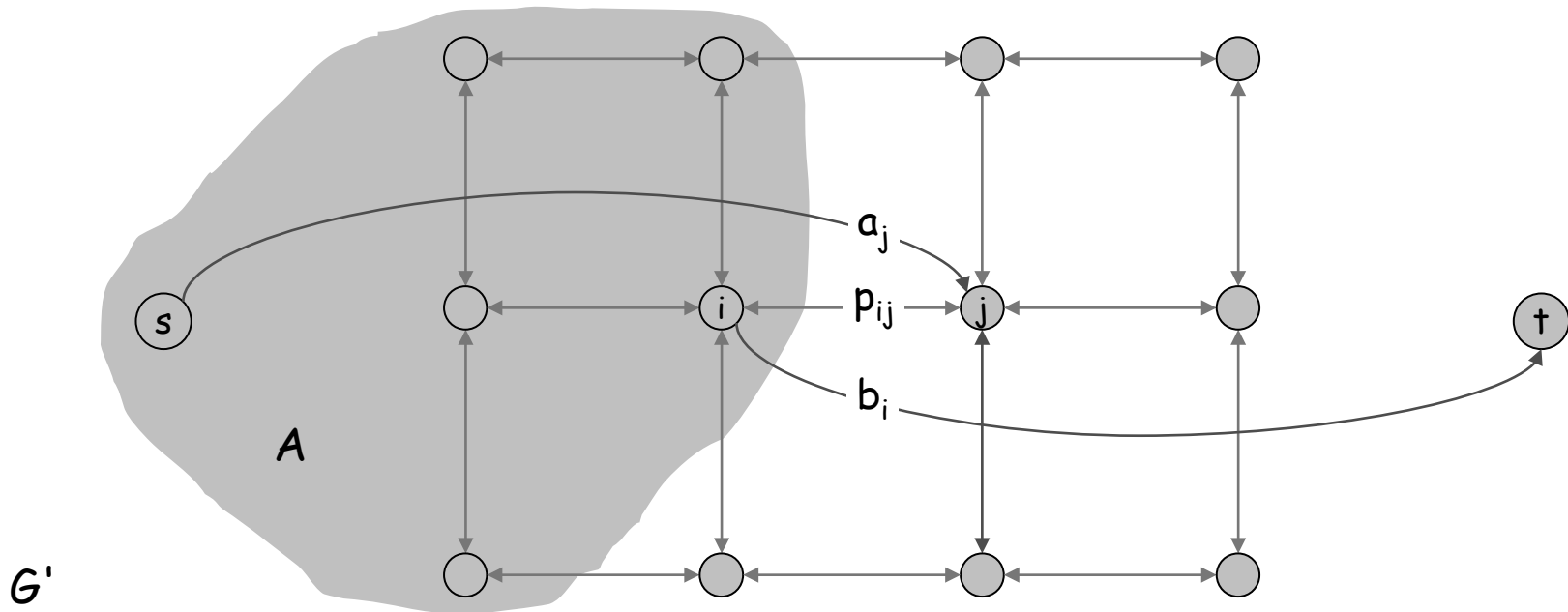

7.11 Project Selection

Project Selection

can be positive or negative

Projects with prerequisites.

Set P of possible projects. Project v has associated revenue p_v .

- some projects generate money: create interactive e-commerce interface, redesign web page
- others cost money: upgrade computers, get site license

Set of prerequisites E . If $(v, w) \in E$, can't do project v and unless also do project w .

A subset of projects $A \subseteq P$ is **feasible** if the prerequisite of every project in A also belongs to A .

Project selection. Choose a feasible subset of projects to maximize revenue.

Project Selection: Prerequisite Graph

Prerequisite graph.

Include an edge from v to w if can't do v without also doing w .

$\{v, w, x\}$ is feasible subset of projects.

$\{v, x\}$ is infeasible subset of projects.

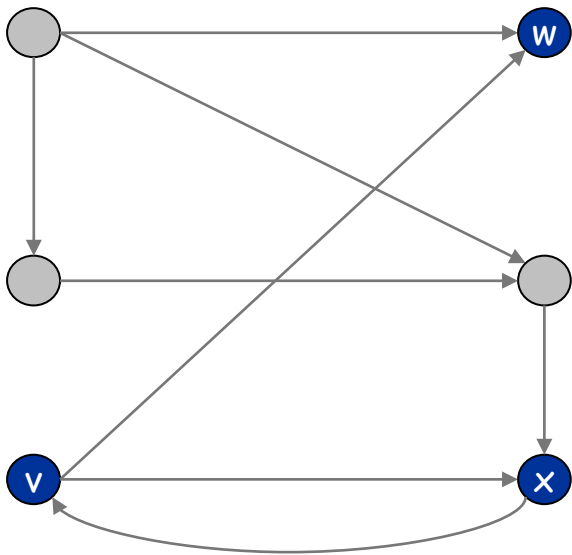

feasible

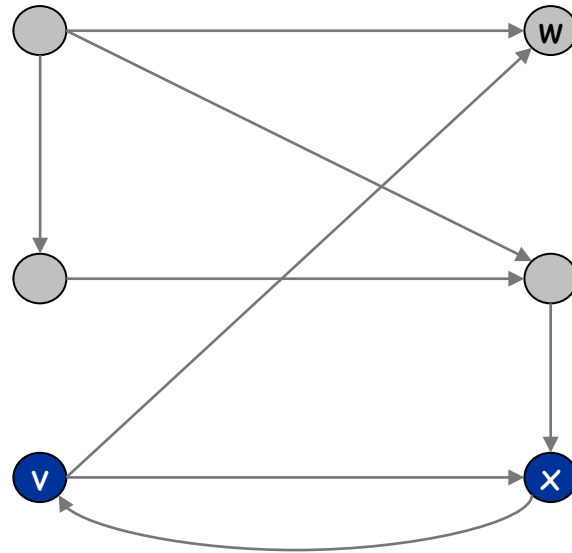

infeasible

Project Selection: Min Cut Formulation

Min cut formulation.

Assign capacity ∞ to all prerequisite edge.

Add edge (s, v) with capacity p_v if $p_v > 0$.

Add edge (v, t) with capacity $-p_v$ if $p_v < 0$.

For notational convenience, define $p_s = p_t = 0$.

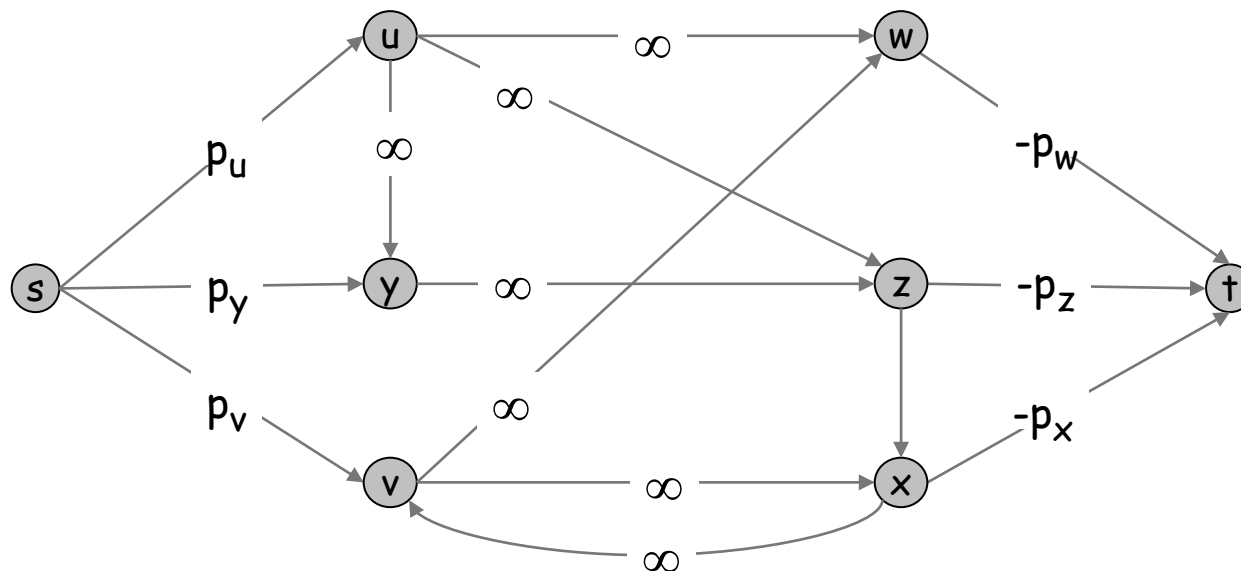

Project Selection: Min Cut Formulation

Claim. (A, B) is min cut iff $A - \{s\}$ is optimal set of projects.

Infinite capacity edges ensure $A - \{s\}$ is feasible.

Max revenue because:

$$\begin{aligned} \text{cap}(A, B) &= \sum_{v \in B: p_v > 0} p_v + \sum_{v \in A: p_v < 0} (-p_v) \\ &= \underbrace{\sum_{v: p_v > 0} p_v}_{\text{constant}} - \sum_{v \in A} p_v \end{aligned}$$

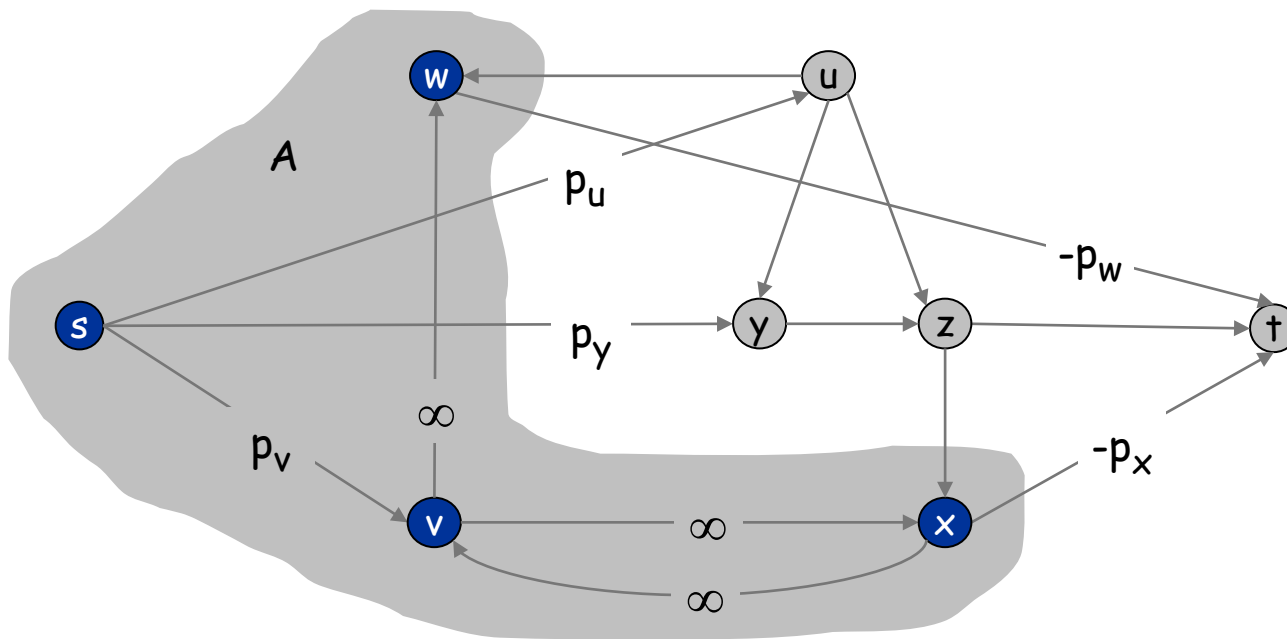

Open Pit Mining

Open-pit mining. (studied since early 1960s)

Blocks of earth are extracted from surface to retrieve ore.

Each block v has net value $p_v = \text{value of ore} - \text{processing cost}$.

Can't remove block v before w or x .

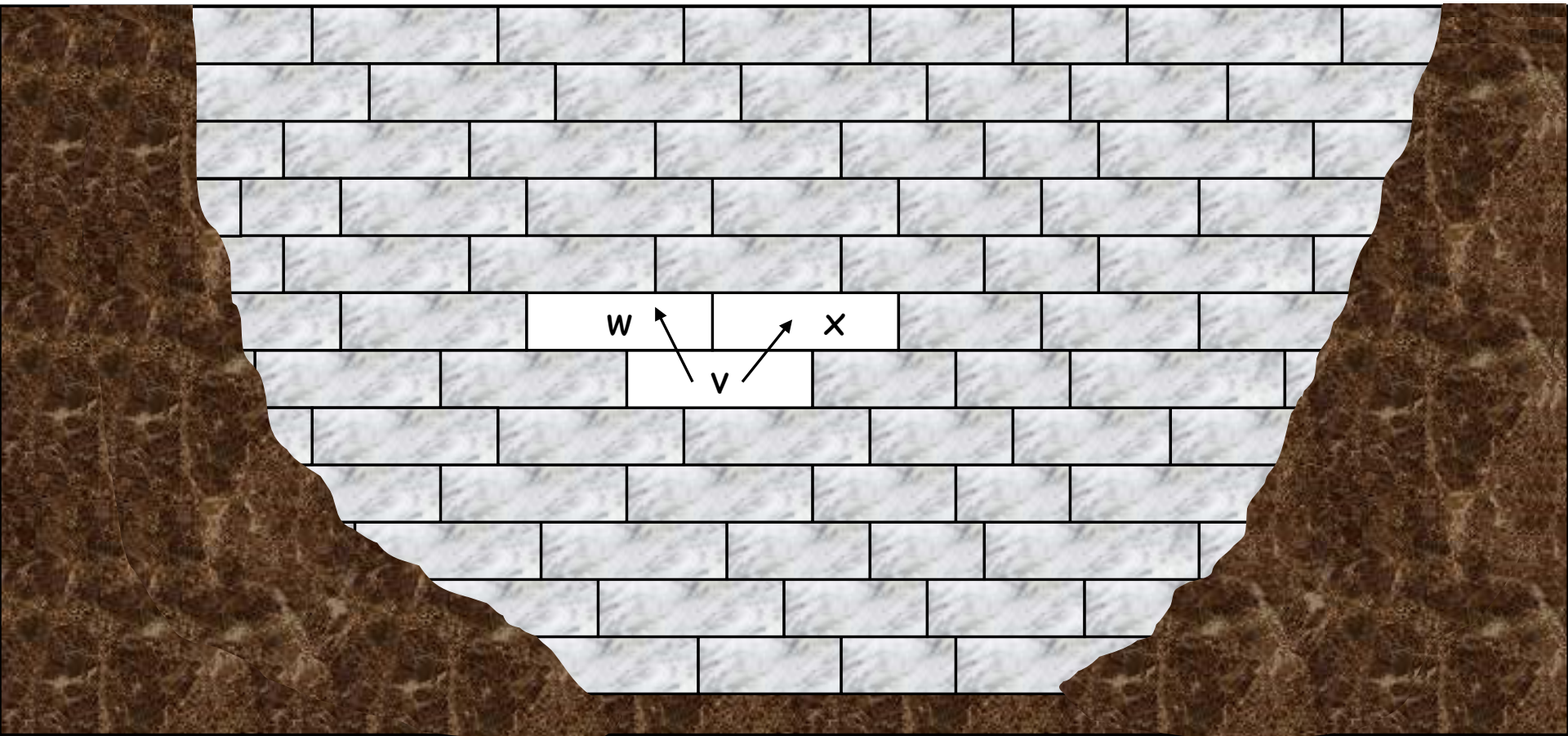

7.12 Baseball Elimination

"See that thing in the paper last week about Einstein? . . . Some reporter asked him to figure out the mathematics of the pennant race. You know, one team wins so many of their remaining games, the other teams win this number or that number. What are the myriad possibilities? Who's got the edge?"

"The hell does he know?"

"Apparently not much. He picked the Dodgers to eliminate the Giants last Friday."

- Don DeLillo, *Underworld*

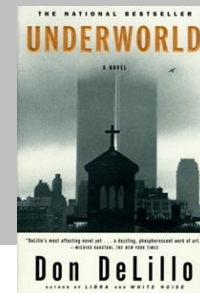

Baseball Elimination

Team i	Wins w_i	Losses l_i	To play r_i	Against = r_{ij}			
				Atl	Phi	NY	Mon
Atlanta	83	71	8	-	1	6	1
Philly	80	79	3	1	-	0	2
New York	78	78	6	6	0	-	0
Montreal	77	82	3	1	2	0	-

Which teams have a chance of finishing the season with most wins?

Montreal eliminated since it can finish with at most 80 wins, but Atlanta already has 83.

$w_i + r_i < w_j \Rightarrow$ team i eliminated.

Only reason sports writers appear to be aware of.

Sufficient, but not necessary!

Baseball Elimination

Team i	Wins w_i	Losses l_i	To play r_i	Against = r_{ij}			
				Atl	Phi	NY	Mon
Atlanta	83	71	8	-	1	6	1
Philly	80	79	3	1	-	0	2
New York	78	78	6	6	0	-	0
Montreal	77	82	3	1	2	0	-

Which teams have a chance of finishing the season with most wins?

Philly can win 83, but still eliminated . . .

Either Atlanta or New York will be over 83, while Philly can reach 83 max.

Remark. Answer depends not just on **how many** games already won and left to play, but also on **whom** they're against.

TUESDAY, SEPTEMBER 10, 1996

San Francisco Chronicle

The Gate

Sports Online

http://www.sfgate.com

SPORTING G

49ers, Young Get Big Breac



Quarterback m

By Gary Swan
Chronicle Staff Writer

The bye week has come at a perfect time for the 49ers and quarterback Steve Young. If they had a game next Sunday, there's a good chance Young would not play.

Put the pulled groin muscle on his up-

Giants Officially Leave the NL West Race

By Nancy Gay
Chronicle Staff Writer

With the smack of another National League West bat 500 miles away, the Giants' run at the division title ended last night, just as they were handing the visiting St. Louis Cardinals an even bigger lead in the NL Central.

CARDINALS 6
GIANTS 2

In San Diego, Greg Vaughn's three-run homer in the eighth pushed the Padres over the Pirates and officially shoved the rest of the Giants' season into the back-ground. On the heels of their tedi-ous 6-2 loss before an announced crowd of 10,307 at Candlestick Park, the Giants fell 19½ games off the lead.

As it is, the worst the Padres (80-65) can finish is 80-82. The Giants have fallen to 59-83 with 20

Financing in Place
For Giants' New Stadium
SEE PAGE B1, MAIN NEWS

games left; they cannot win 80 games. Coming off a miserable 2-8 mark on a three-city road trip that saw their road record drop to 27-47, the Giants were hoping to get off on the right foot in their long-est homestand of the year (15 games, 14 days).

"Where we are, you're going to be eliminated sooner or later," Baker said quietly. "But it doesn't alter the fact that we've still got to play ball. You've still got to play hard, the fans come out to watch you play. You've got to play for the fact of loving to play, no matter where you are in the standings.

"You've got to play the role of spoiler, to not make it easier on

GIANTS: Page D5 Col. 3

Baseball Elimination

Baseball elimination problem.

Set of teams S .

Distinguished team $s \in S$.

Team x has won w_x games already.

Teams x and y play each other r_{xy} additional times.

Is there any outcome of the remaining games in which team s finishes with the most (or tied for the most) wins?

Baseball Elimination: Max Flow Formulation

Can team 3 finish with most wins?

Assume team 3 wins all remaining games $\Rightarrow w_3 + r_3$ wins.

Divvy remaining games so that all teams have $\leq w_3 + r_3$ wins.

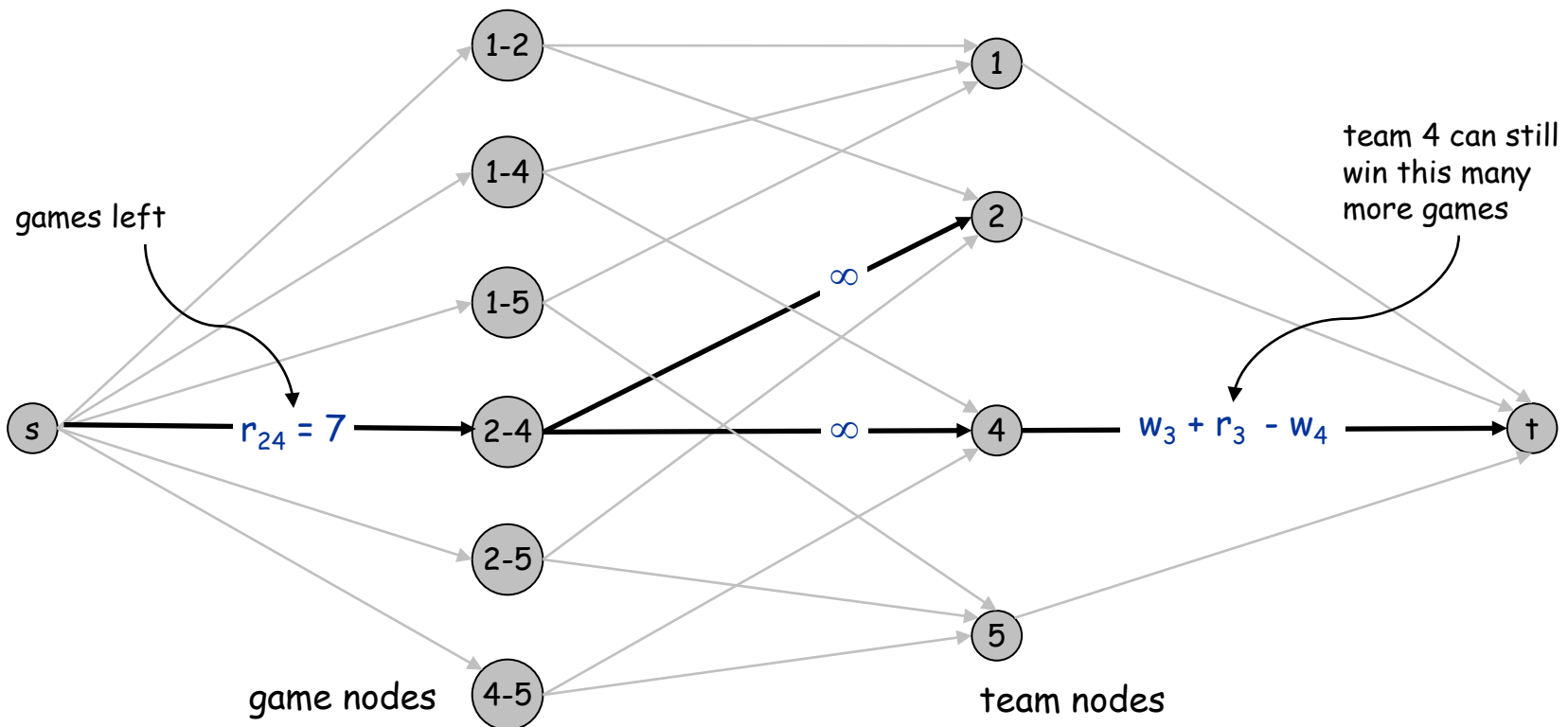

Baseball Elimination: Max Flow Formulation

Theorem. Team 3 is not eliminated iff max flow saturates all edges leaving source.

Integrality theorem \Rightarrow each remaining game between x and y added to number of wins for team x or team y .

Capacity on (x, t) edges ensure no team wins too many games.

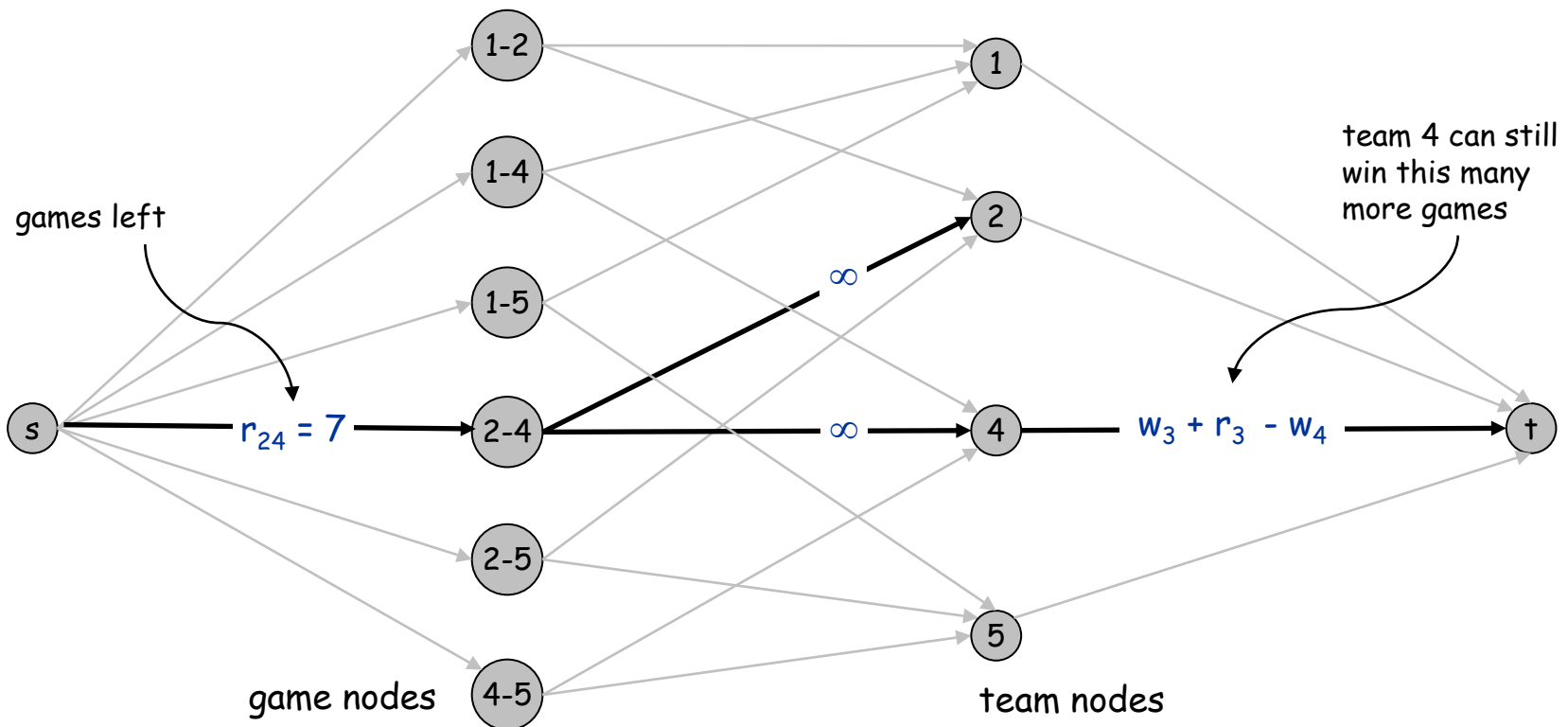

Baseball Elimination: Explanation for Sports Writers

Team i	Wins w_i	Losses l_i	To play r_i	Against = r_{ij}				
				NY	Bal	Bos	Tor	Det
NY	75	59	28	-	3	8	7	3
Baltimore	71	63	28	3	-	2	7	4
Boston	69	66	27	8	2	-	0	0
Toronto	63	72	27	7	7	0	-	-
Detroit	49	86	27	3	4	0	0	-

AL East: August 30, 1996

Which teams have a chance of finishing the season with most wins?

Detroit could finish season with $49 + 27 = 76$ wins.

Baseball Elimination: Explanation for Sports Writers

Team i	Wins w_i	Losses l_i	To play r_i	Against = r_{ij}				
				NY	Bal	Bos	Tor	Det
NY	75	59	28	-	3	8	7	3
Baltimore	71	63	28	3	-	2	7	4
Boston	69	66	27	8	2	-	0	0
Toronto	63	72	27	7	7	0	-	-
Detroit	49	86	27	3	4	0	0	-

AL East: August 30, 1996

Which teams have a chance of finishing the season with most wins?

Detroit could finish season with $49 + 27 = 76$ wins.

Certificate of elimination. $R = \{NY, Bal, Bos, Tor\}$

Have already won $w(R) = 278$ games.

Must win at least $r(R) = 27$ more.

Average team in R wins at least $305/4 > 76$ games.

Baseball Elimination: Explanation for Sports Writers

Certificate of elimination.

$$T \subseteq S, \quad w(T) := \overbrace{\sum_{i \in T} w_i}^{\# \text{ wins}}, \quad g(T) := \overbrace{\sum_{\{x,y\} \subseteq \bar{T}} g_{x,y}}^{\# \text{ remaining games}},$$

If $\overbrace{\frac{w(T) + g(T)}{|T|}}^{\text{LB on avg \# games won}} > w_z + g_z$ then z is **eliminated** (by subset T).

Theorem. [Hoffman-Rivlin 1967] Team z is eliminated iff there exists a subset T^* that eliminates z .

Proof idea. Let T^* = team nodes on source side of min cut.

Baseball Elimination: Explanation for Sports Writers

Pf of theorem.

Use max flow formulation, and consider min cut (A, B) .

Define T^* = team nodes on source side of min cut.

Observe $x-y \in A$ iff both $x \in T^*$ and $y \in T^*$.

- infinite capacity edges ensure if $x-y \in A$ then $x \in A$ and $y \in A$
- if $x \in A$ and $y \in A$ but $x-y \in T$, then adding $x-y$ to A decreases capacity of cut

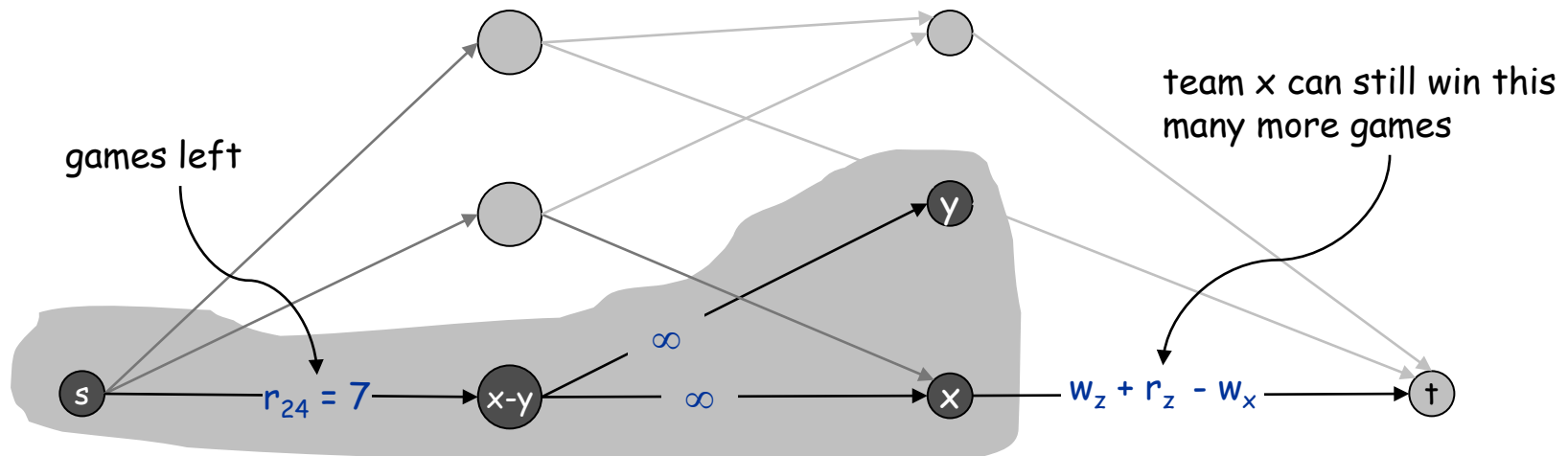

Baseball Elimination: Explanation for Sports Writers

Pf of theorem.

Use max flow formulation, and consider min cut (A, B) .

Define T^* = team nodes on source side of min cut.

Observe $x-y \in A$ iff both $x \in T^*$ and $y \in T^*$.

$$\begin{aligned} g(S - \{z\}) &> \text{cap}(A, B) \\ &= \overbrace{g(S - \{z\}) - g(T^*)}^{\text{capacity of game edges leaving } s} + \overbrace{\sum_{x \in T^*} (w_z + g_z - w_x)}^{\text{capacity of team edges leaving } s} \\ &= g(S - \{z\}) - g(T^*) - w(T^*) + |T^*|(w_z + g_z) \end{aligned}$$

Rearranging terms: $w_z + g_z < \frac{w(T^*) + g(T^*)}{|T^*|}$ ■

Extra Slides

Census Tabulation (Exercise 7.39)

Feasible matrix rounding.

Given a p -by- q matrix $D = \{d_{ij}\}$ of **real** numbers.

Row i sum = a_i , column j sum b_j .

Round each d_{ij} , a_i , b_j up or down to integer so that sum of rounded elements in each row (column) equals row (column) sum.

Original application: publishing US Census data.

Goal. Find a feasible rounding, if one exists.

3.14	6.8	7.3	17.24
9.6	2.4	0.7	12.7
3.6	1.2	6.5	11.3
16.34	10.4	14.5	

original matrix

3	7	7	17
10	2	1	13
3	1	7	11
16	10	15	

feasible rounding

Census Tabulation

Feasible matrix rounding.

Given a p -by- q matrix $D = \{d_{ij}\}$ of **real** numbers.

Row i sum = a_i , column j sum b_j .

Round each d_{ij} , a_i , b_j up or down to integer so that sum of rounded elements in each row (column) equals row (column) sum.

Original application: publishing US Census data.

Goal. Find a feasible rounding, if one exists.

Remark. "Threshold rounding" can fail.

0.35	0.35	0.35	1.05
0.55	0.55	0.55	1.65
0.9	0.9	0.9	

original matrix

0	0	1	1
1	1	0	2
1	1	1	

feasible rounding

Census Tabulation

Theorem. Feasible matrix rounding always exists.

Pf. Formulate as a circulation problem with lower bounds.

Original data provides circulation (all demands = 0).

Integrality theorem \Rightarrow integral solution \Rightarrow feasible rounding. ■

3.14	6.8	7.3	17.24
9.6	2.4	0.7	12.7
3.6	1.2	6.5	11.3
16.34	10.4	14.5	

